

Overview of EPRV instruments

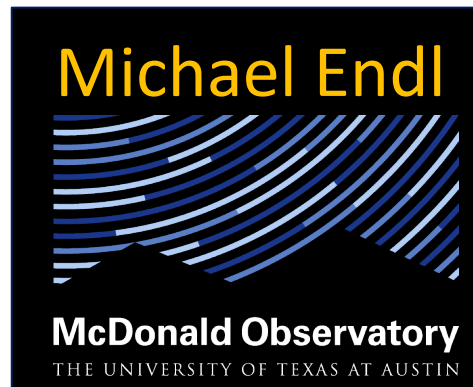
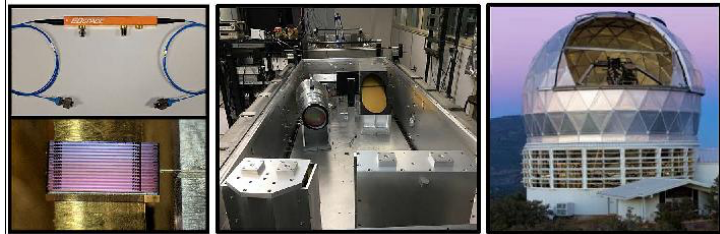
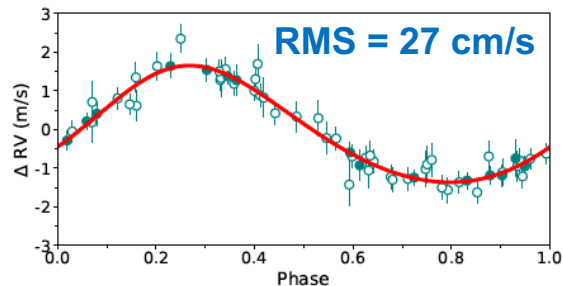
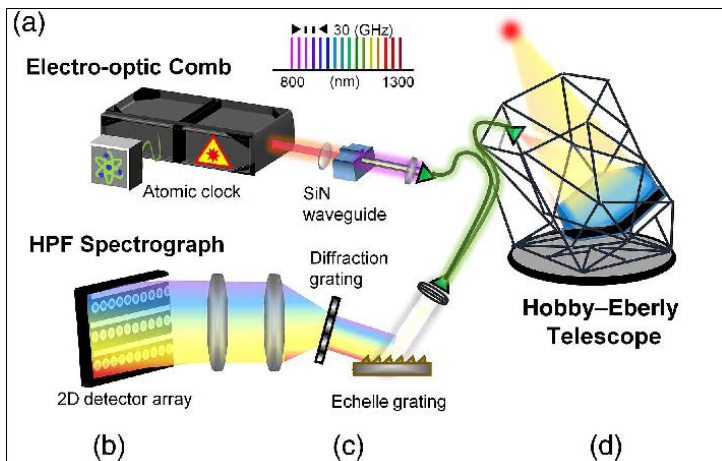

Overview of EPRV instruments

The Basics:

- Bandwidth & Wavelength (optical, NIR,..)
- Resolving Power (R)

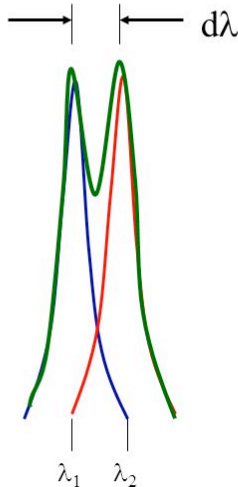

- Signal/Noise

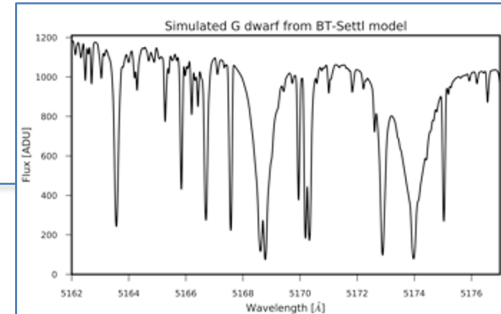

Consider two monochromatic beams

They will just be resolved when they have a wavelength separation of $d\lambda$

Resolving power:

$$R = \frac{\lambda}{d\lambda}$$

$d\lambda$ = full width of half maximum of calibration lamp emission lines

Overview of EPRV instruments

The Basics:

- Spectrograph stability:
 - opto-mechanical (no moving parts)
 - controlled environment
 - detector

10 cm/s \sim 1 nm detector

- Stability of illumination (PSF stability):
 - fiber/image scrambling
 - fiber modal noise mitigation

- Calibration:
 - reference lamp (e.g. Th-Ar)
 - laser comb
 - Fabry-Perot Etalons

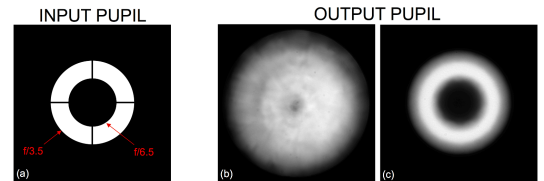

(Sutherland et al. 2016)

List of current EPRV instruments:

Optical:

- **HARPS (ESO 3.6m)**
- HARPS-N (TNG 3.6m)
- **ESPRESSO (ESO VLT)**
- **CARMENES (CA 3.5m)**
- EXPRESS (DCT)
- CHIRON (CTIO)
- Levy (APF)
- PSF (Magellan)
- **NEID (WIYN)**
-

NIR:

- **CARMENES (CA 3.5m)**
- **HPF (HET)**
- SPIRou (CFHT)
- ...

Future:

- Maroon-X (Gemini-N)
- KPF (Keck)
- HARPS3 (INT)
- GCLEF (GMT)
- MODHIS (TMT)
- ...

HARPS the first EPRV instrument:

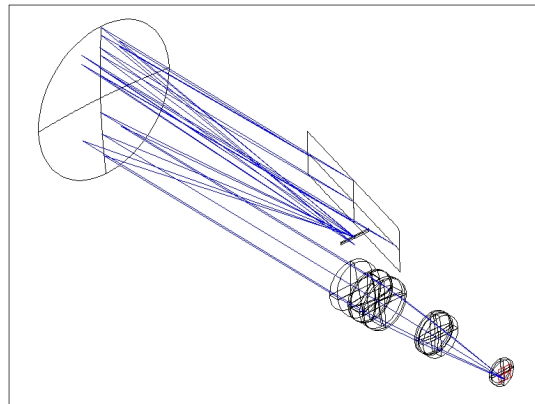
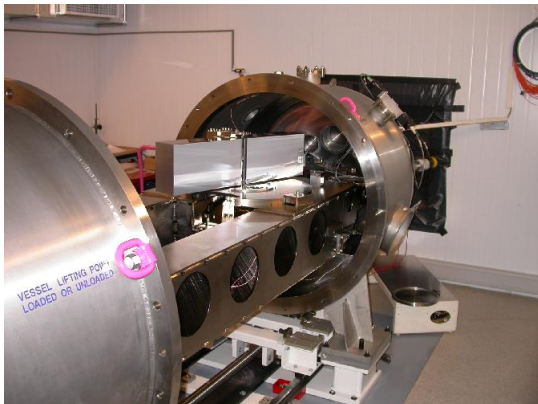

Vacuum tank, R~115,000
378 – 691 nm (2 CCDs)
No moving parts
Simultaneous Th-Ar calibration
in operation since 2003

Clones:
HARPS-N at TNG
Future: HARPS3 (INT)

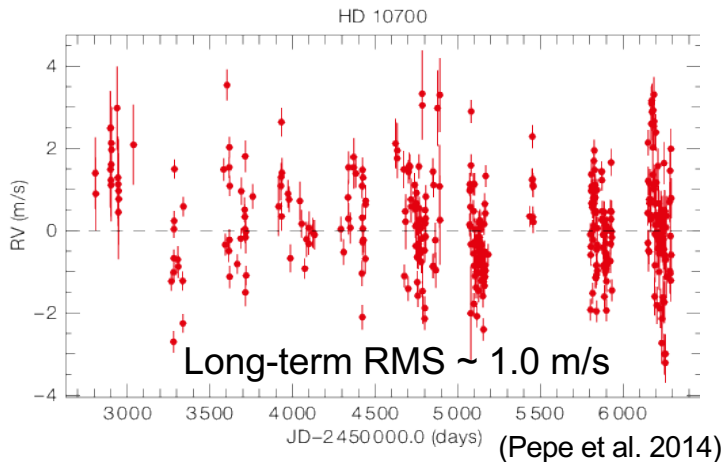

ESPRESSO (ESO VLT):

Combined Coudé Lab:

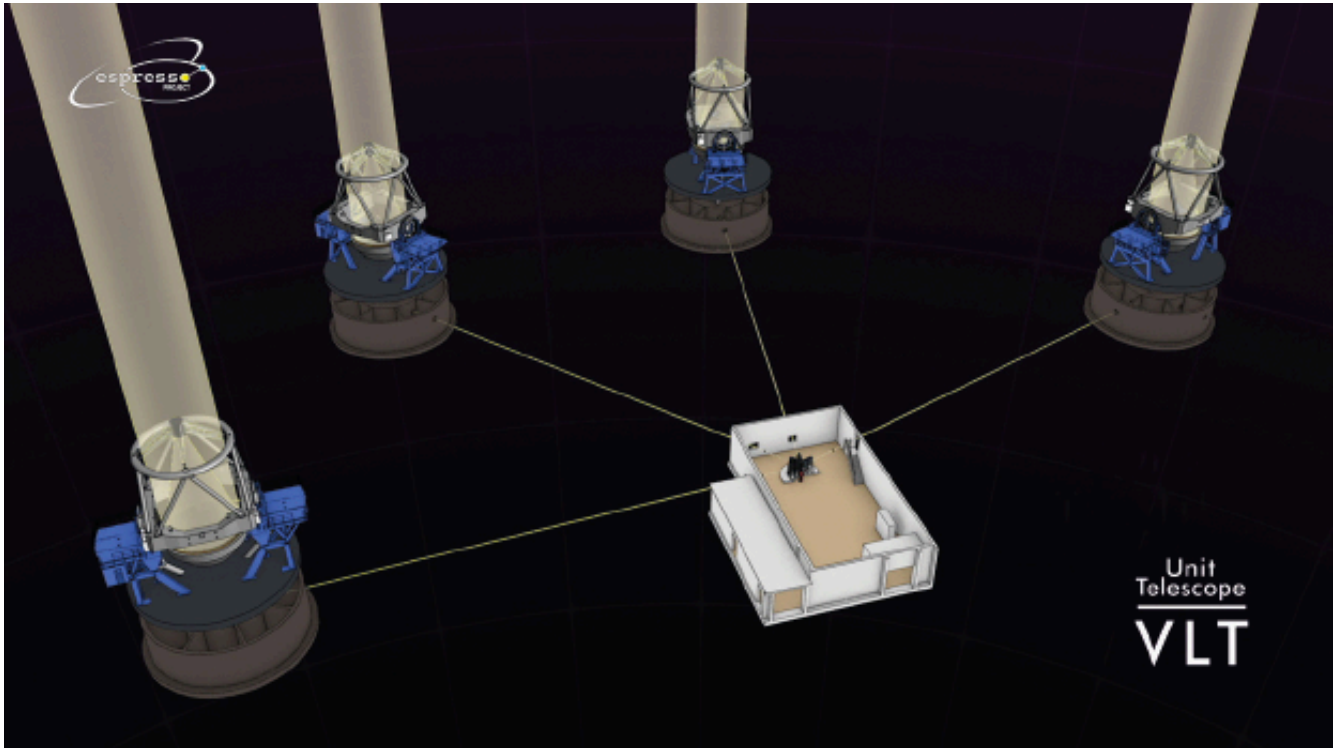

ESPRESSO (ESO VLT):

Optical Layout:

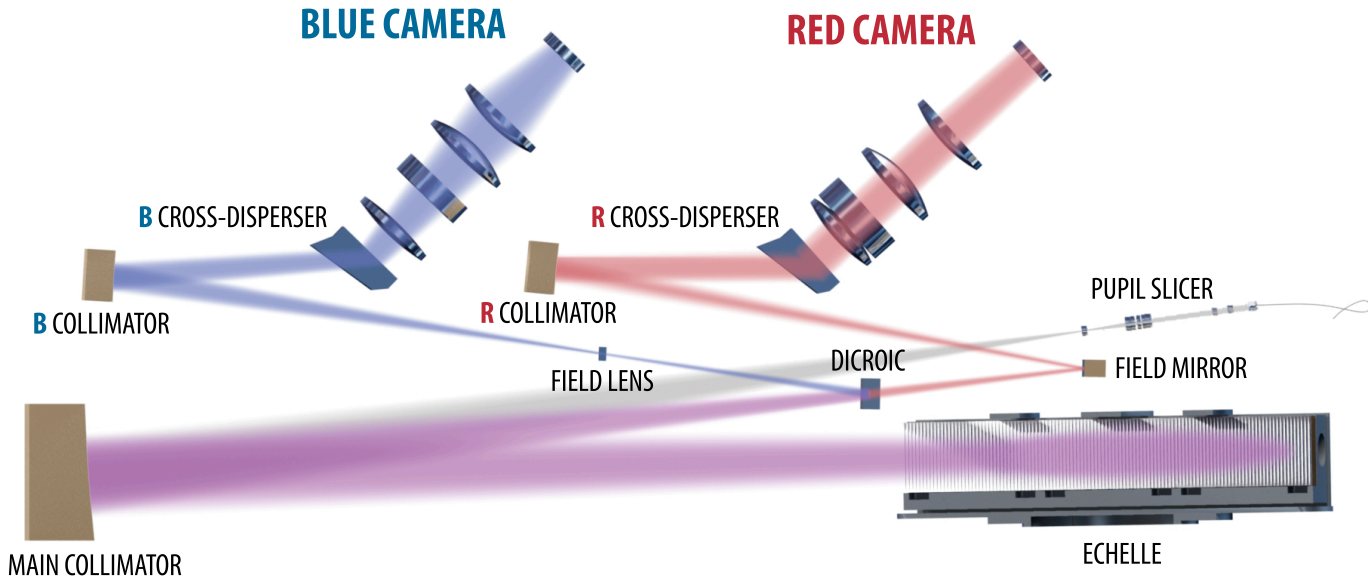

ESPRESSO (ESO VLT):

Instrument enclosure:

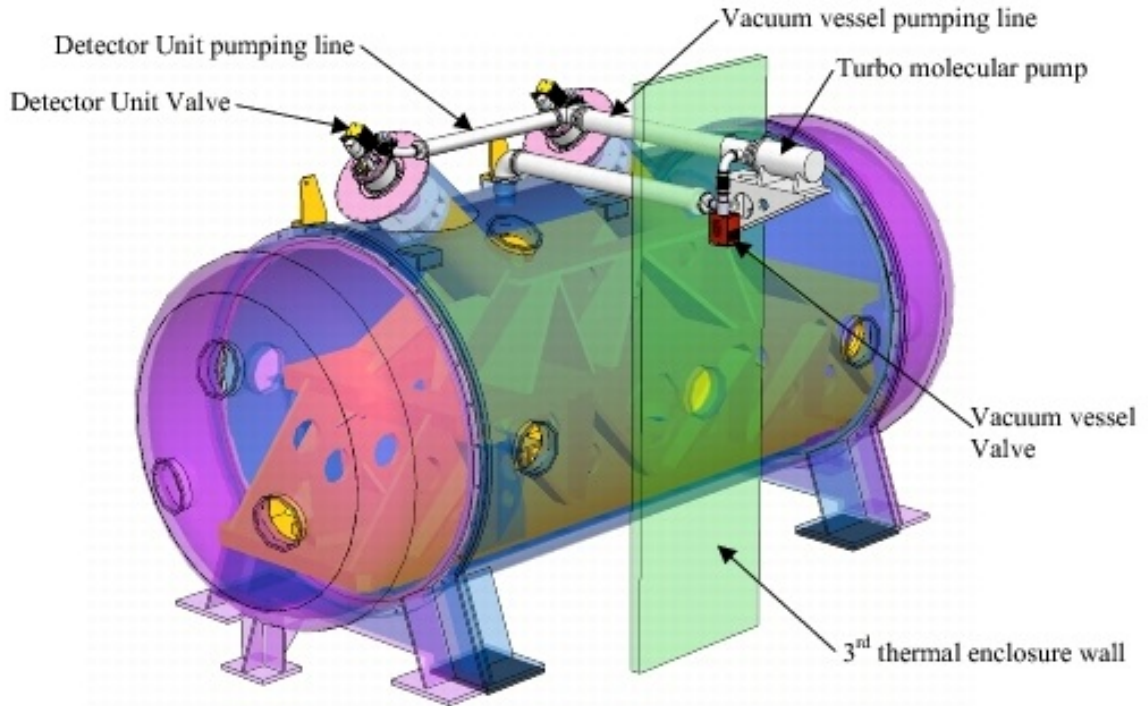

ESPRESSO (ESO VLT):

Parameter	<i>singleUHR</i>	<i>singleHR</i>	<i>multiMR</i>
Wavelengths	Blue arm: 380 – 520 nm Red arm: 520 – 780 nm		
Spectral coverage	Full		
Spectra format	Echelle, up to 4 spectra per order (2 fibers, 2 spectra / fiber)		
Resolving power	225'000	134'000	59'000
Aperture on sky	0.5 arcsec	1.0 arcsec	4x1.0 arcsec
Spectral sampling	2.5 pixels	4.5 pixels	10 pixels
Spatial sampling	9 pixels	18 pixels	44 pixels
Available binning	1x1	1x1 or 2x1	4x2 or 8x4
Sky/Simultaneous reference	Yes (mutually exclusive)		
Instrumental RV precision	<10 cm/s	<10 cm/s	~1 m/s

ESPRESSO (ESO VLT):

Short-term RV precision:

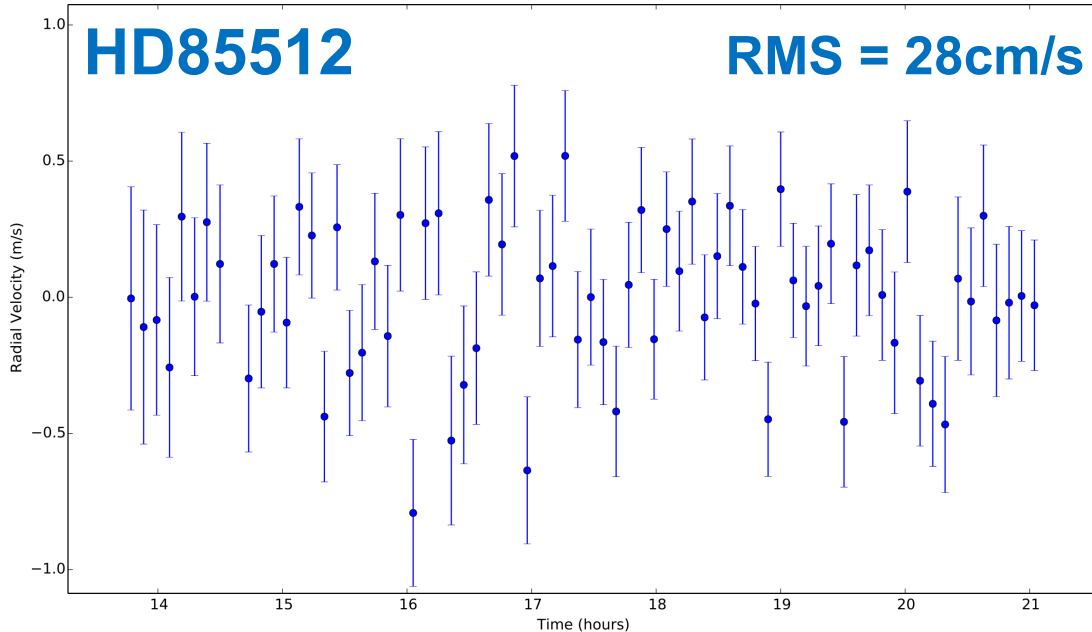

Benchmarks: $M_v=7.65$, $T_{\text{exp}} = 5$ min. \rightarrow 25 cm/s
 $M_v=10$, $T_{\text{exp}} = 2.5$ min. \rightarrow 1 m/s
 $M_v= 4$, $T_{\text{exp}} = 1$ min. \rightarrow 10 cm/s

ESPRESSO (ESO VLT):

Proxima b: long-term RV precision:

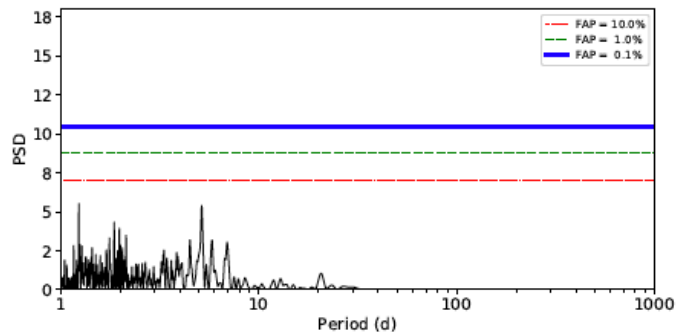
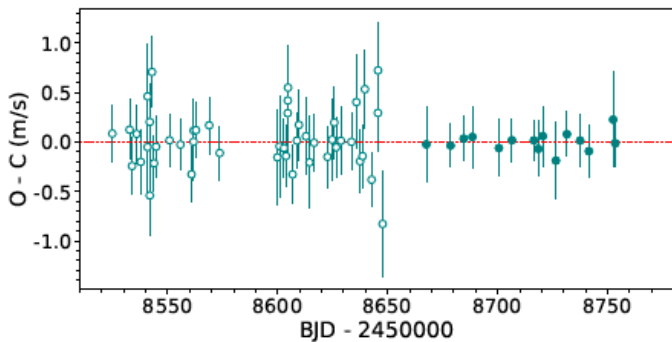
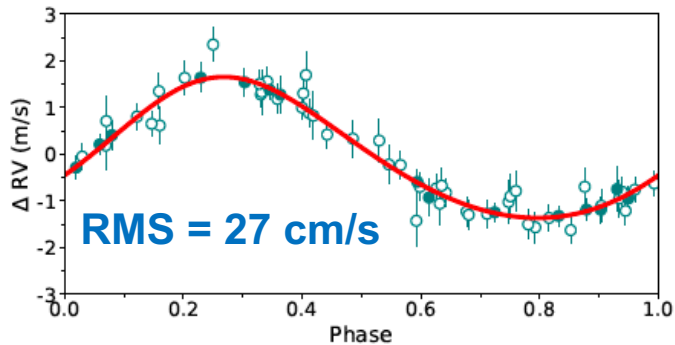
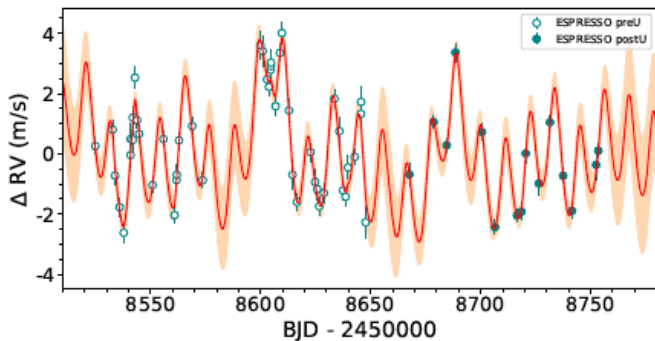

Properties of the CARMENES Spectrographs



- Optical spectrograph
 - 0.53 ... 1.05 μm , $R = 94,600$
 - Precision ~ 1 m/s
 - Vacuum tank, temperature stabilized
 - 4k x 4k deep depletion CCD detector
- Near-Infrared spectrograph
 - 0.95 ... 1.7 μm , $R = 80,400$
 - Vacuum tank, cooled to 140K, stabilized
 - Precision goal 1 m/s
 - Two 2k x 2k HAWAII-2RG 2.5 μm detectors

Instrument Overview

Fabry-Perot etalon:
halogen-tungsten lamp
~9,700 lines

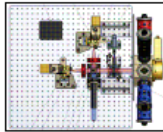

NIR CalUnit

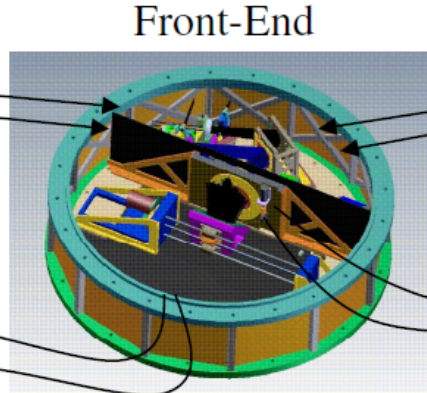

Front-End

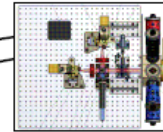

VIS CalUnit

Fabry-Perot etalon:
halogen-tungsten
~17,900 lines

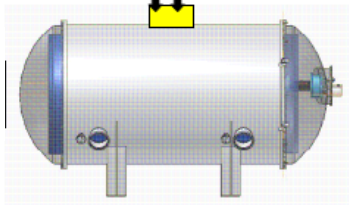

NIR Spectrograph

Cooling System
Vac.system
Sensors
MCE

ICS
GUI
Scheduler
Pipeline

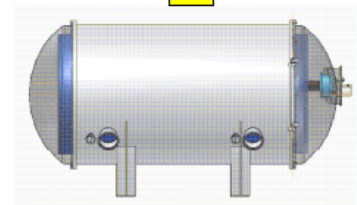

VIS Spectrograph

NIR 28 orders
0.96-1.71 μm

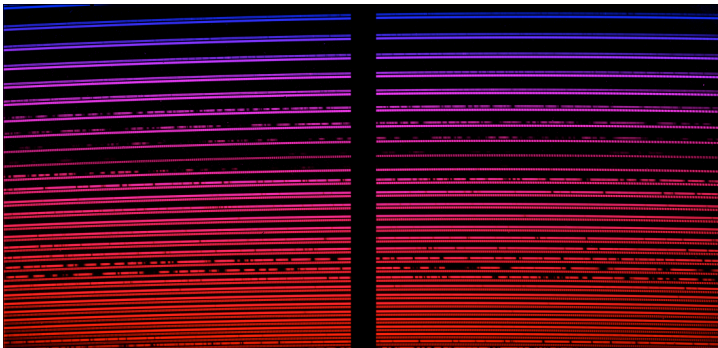

VIS 61 orders
0.52-0.96 μm

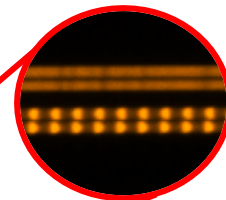

RV Precision for Different Wavelength Bands

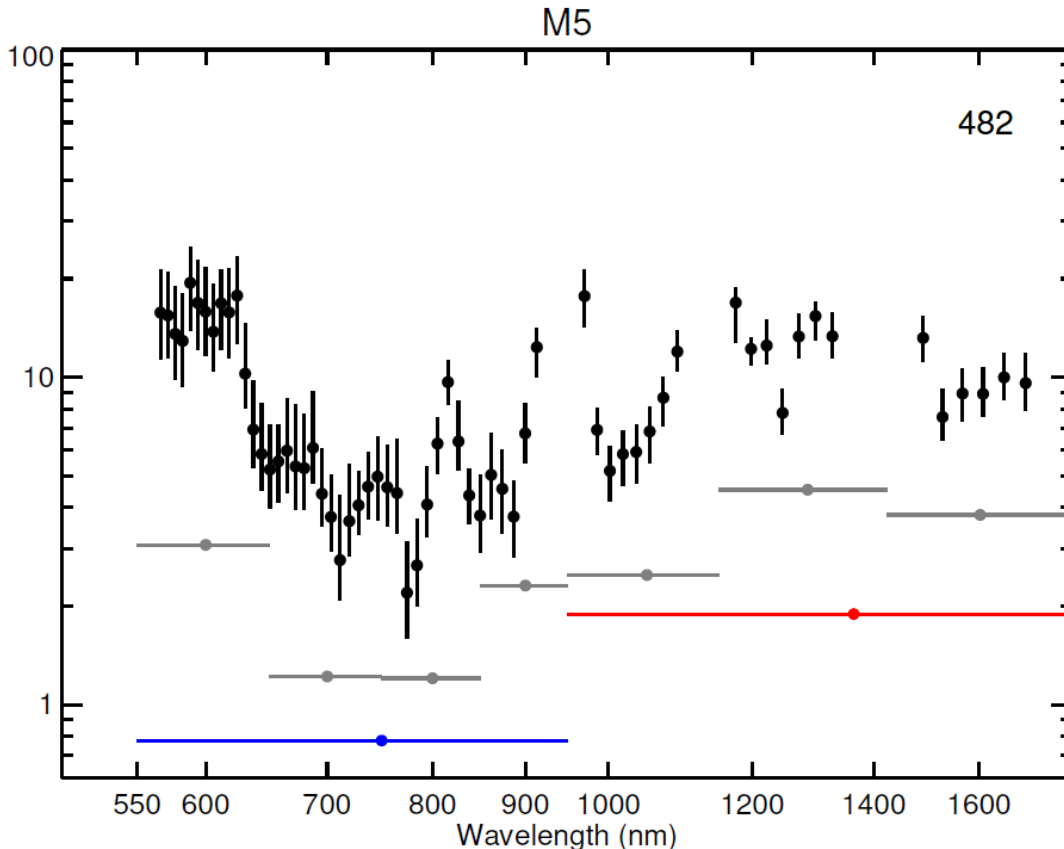

Reiners et al.
(A&A 2018)

Comparison with HARPS

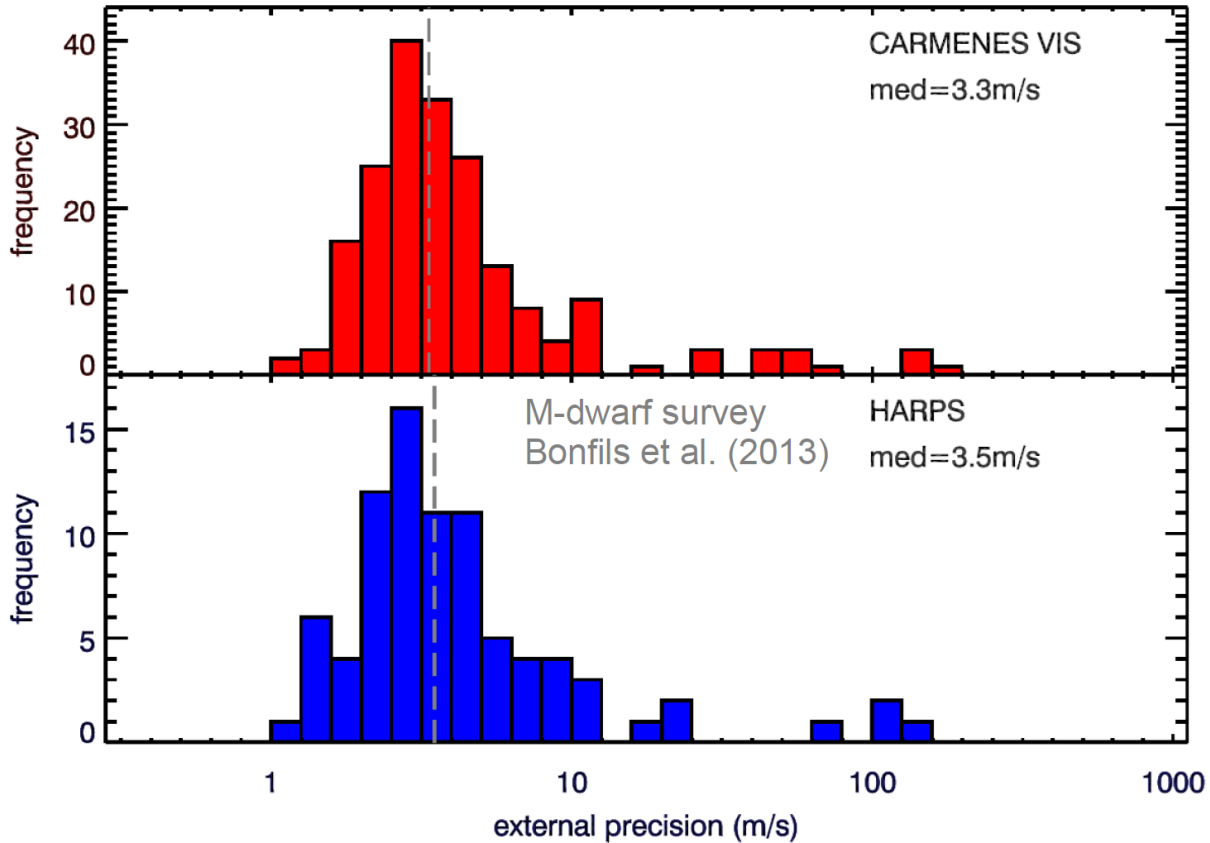

HPF @ HET:

Radiation shield

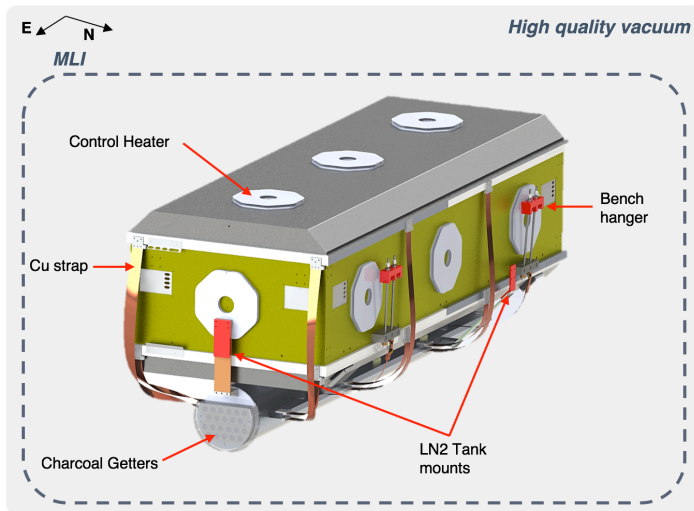

Optical Bench

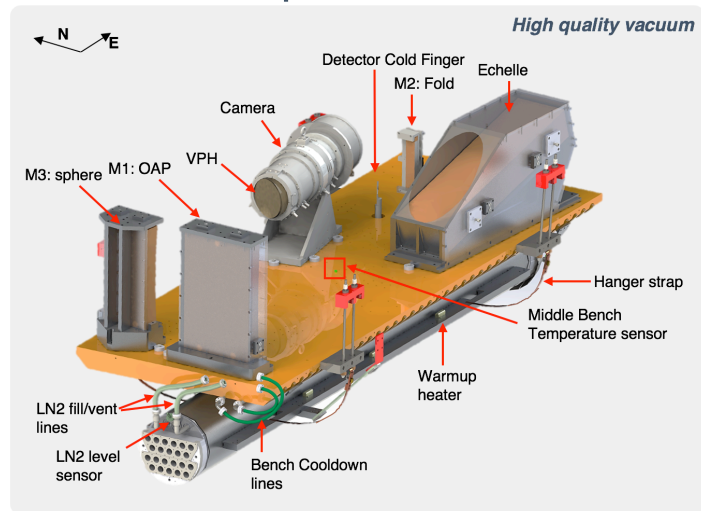

- white pupil spectrograph, vacuum cryostat cooled to 180 K (at milli-kelvin level)
- gold-coated mirrors & mosaic echelle grating
- single Teledyne Hawaii-2RG (H2RG) NIR detector with 1.7-micron cutoff
- covering parts of the information rich z, Y and J NIR bands (800-1300 nm)
- spectral resolution of $R \sim 50,000$
- near and far-field fiber scrambling, double scramblers and octagonal fibers.
- **Optimized for PRVs of mid M dwarfs (M4/5)**

HPF @ HET:

30 GHz optical frequency comb spanning 700–1600 nm

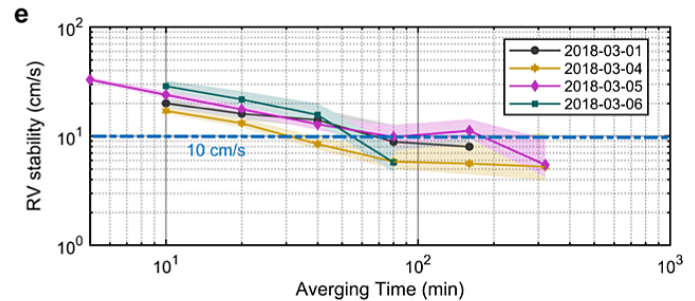
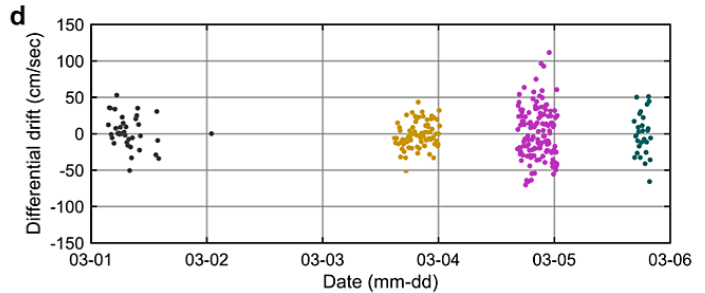
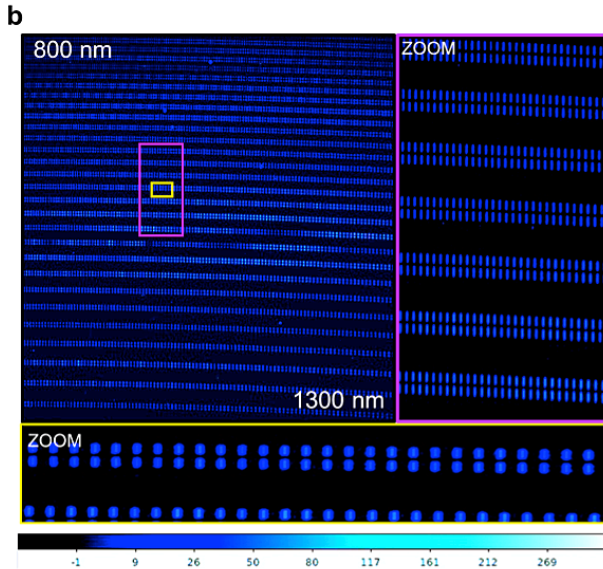
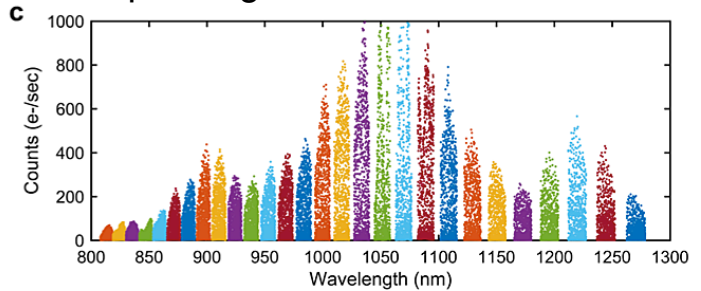
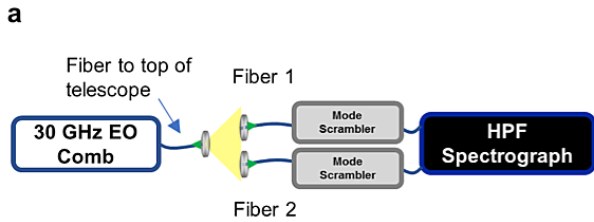

HPF @ HET:

30 GHz optical frequency comb spanning 700–1600 nm

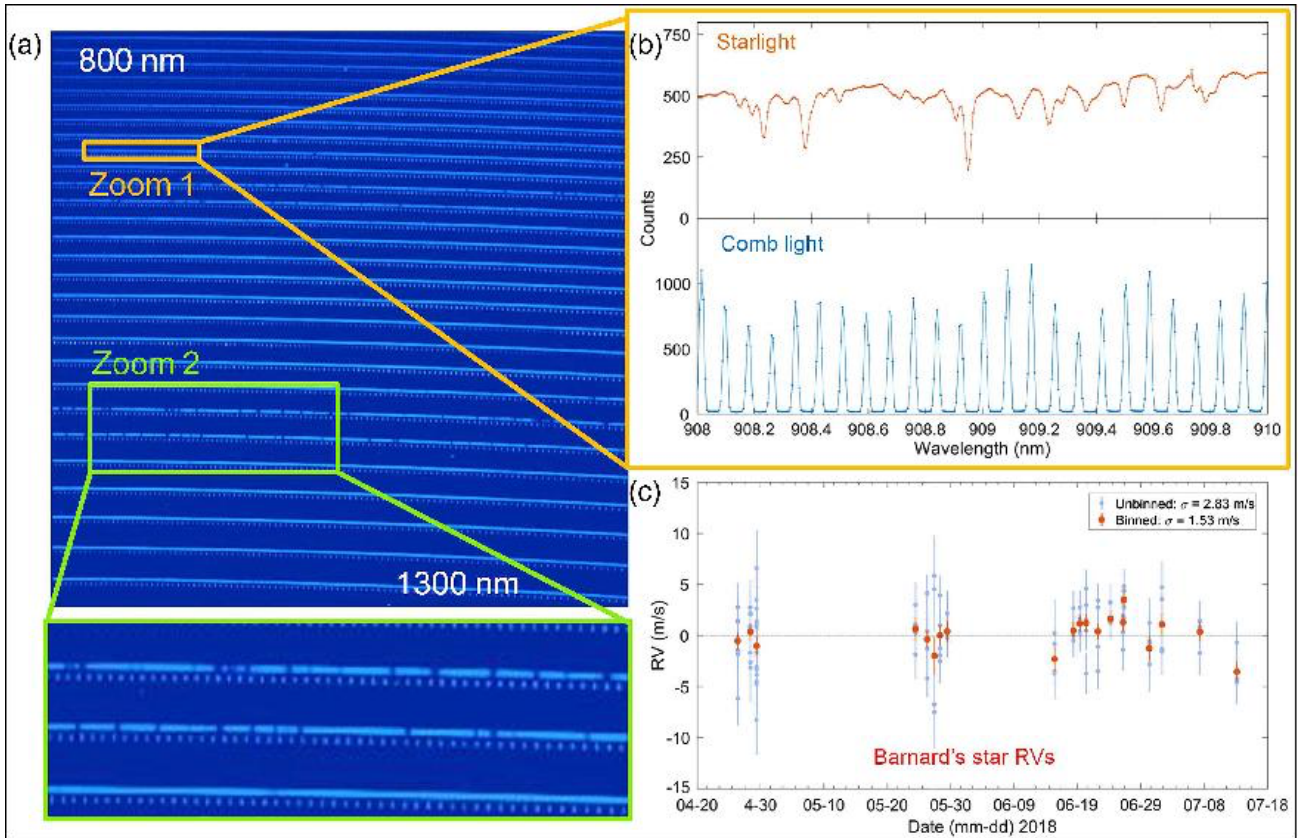



NN·EXPLORE

Partnership for Exoplanet Discovery and Characterization

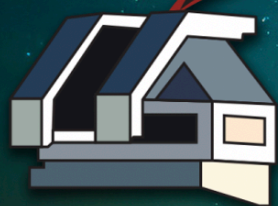

NEID

NN-exlore Exoplanet Investigations with Doppler Spectroscopy





Telescope: 3.5m WIYN Telescope @ KPNO

Waveband & Resolution: 380 – 930 nm, complete coverage, $R \sim 120K$

Expected Precision: ~ 30 cm/s baseline goal (single measurement precision)

Commissioning Started but interrupted by Covid-19 shutdown

Available to the Public via NN-EXPLORE

Two Observing Modes:

- HR ($R \sim 120,000$)
 - Highest precision RVs on bright targets ($V < 12$, e.g. TESS)
 - Simultaneous Cal
- HE ($R \sim 60,000$)
 - Faint targets ($V < 16$)
 - Poor weather
 - e.g. K2

NEID Optical Design:

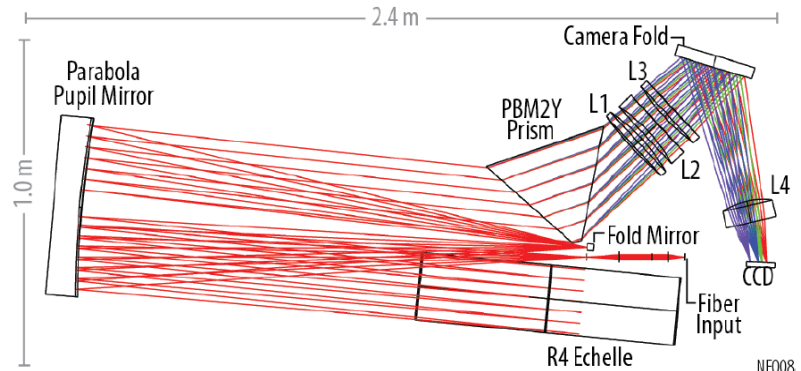

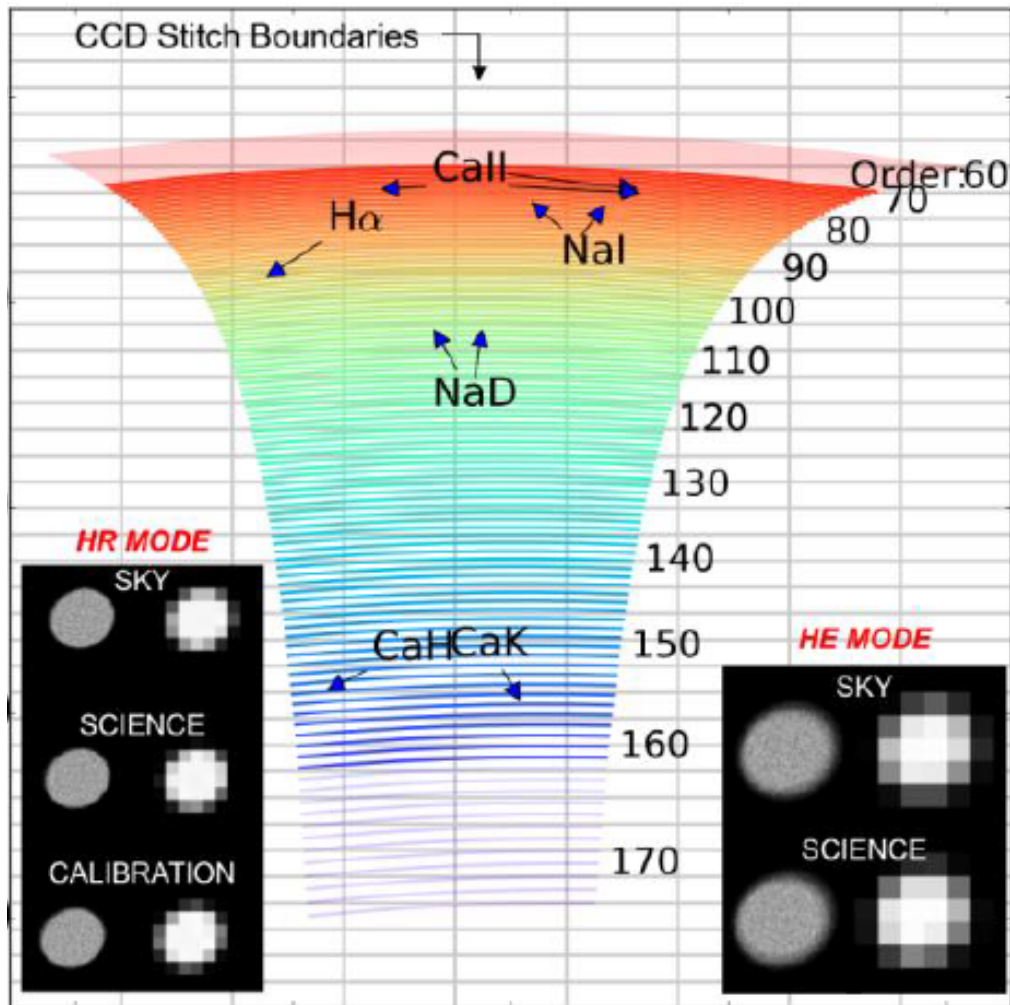

Total NEID instrumental error budget: 27.0 cm s⁻¹

Instrument (uncalibratable):
15.1 cm s⁻¹ (30.6%)

Fiber & illumination: 8.7 cm s⁻¹

Calibration source modal noise	2.5 cm s ⁻¹
Continuum modal noise	2.5 cm s ⁻¹
Near-field scrambling	3.5 cm s ⁻¹
Far-field scrambling	5.0 cm s ⁻¹
Stray light	5.0 cm s ⁻¹
Polarization	2.0 cm s ⁻¹

Detector effects: 7.1 cm s⁻¹

Readout thermal change	5.0 cm s ⁻¹
Charge transfer inefficiency	5.0 cm s ⁻¹

Barycentric correction: 1.7 cm s⁻¹

Algorithms	1.0 cm s ⁻¹
Exposure midpoint time	1.0 cm s ⁻¹
Coordinates and proper motion	1.0 cm s ⁻¹

Reduction pipeline: 10 cm s⁻¹

Software algorithms	10 cm s ⁻¹
---------------------	-----------------------

25%

Instrument (calibratable):
11.2 cm s⁻¹ (1.1%)

Thermo-mechanical: 7.8 cm s⁻¹

Thermal stability (grating)	3.5 cm s ⁻¹
Thermal stability (cross-disp.)	3.0 cm s ⁻¹
Thermal stability (bench)	3.0 cm s ⁻¹
Vibrational stability	2.0 cm s ⁻¹
Pressure stability	<0.1 cm s ⁻¹
LN2 fill transient	1.0 cm s ⁻¹
Zerodur phase change	5.0 cm s ⁻¹

Detector effects: 8.1 cm s⁻¹

Pixel inhomogeneities	1.0 cm s ⁻¹
Electronics noise	1.0 cm s ⁻¹
Stitching error	3.0 cm s ⁻¹
CCD thermal expansion	2.0 cm s ⁻¹
Readout thermal change	5.0 cm s ⁻¹
Charge transfer inefficiency	5.0 cm s ⁻¹

Calibration source (uncalibratable):
11.5 cm s⁻¹ (18.7%)

Calibration accuracy: 5.7 cm s⁻¹

Stability	4.0 cm s ⁻¹
Photon noise	4.0 cm s ⁻¹

External errors (uncalibratable):
18.7 cm s⁻¹ (49.6%)

Calibration process: 10 cm s⁻¹

Software algorithms	10 cm s ⁻¹
---------------------	-----------------------

Telescope: 12.2 cm s⁻¹

Guiding	scrambling
ADC	6.9 cm s ⁻¹
Focus	5.0 cm s ⁻¹
Windshake	8.0 cm s ⁻¹

Atmospheric effects: 14.1 cm s⁻¹

Micro-telluric contamination	10 cm s ⁻¹
Sky fiber subtraction	10 cm s ⁻¹

Dec. 13, 2019. NEID First Light: 51 Pegasi

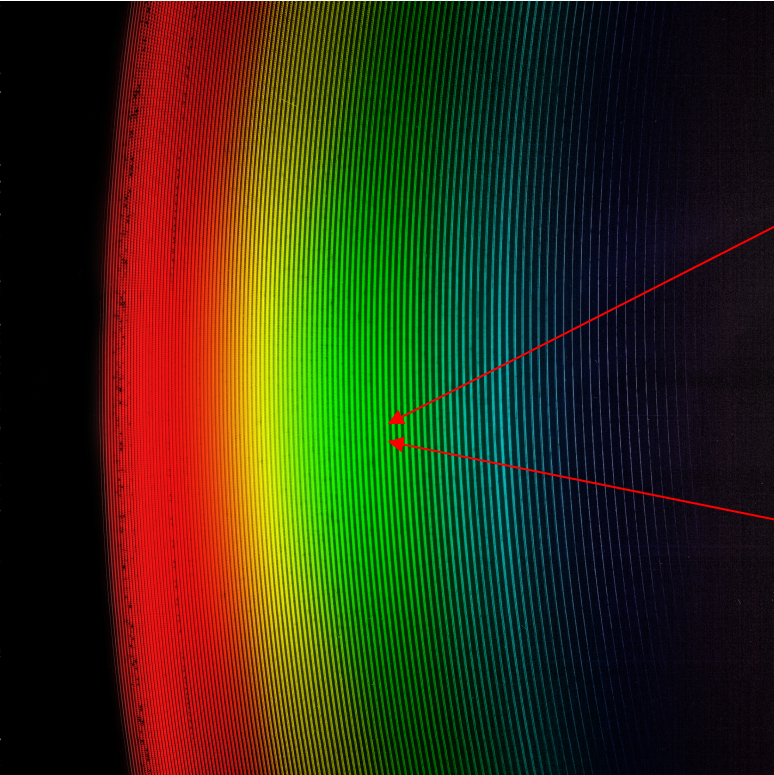

930nm

Wavelength

380nm

NEID order trace:

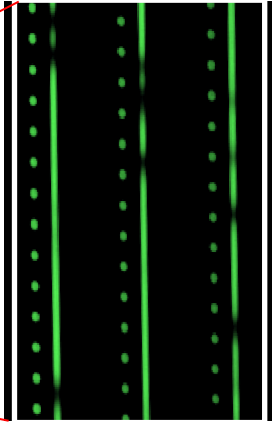

Calibration

Star

- Data will be fully reduced by the data reduction pipeline provided by the instrument team
- Every PI will have access to high-quality RVs produced by a common pipeline
- The archive will host three levels of reduced data for each observation:



- **Level 0 - Raw data**

- One FITS file for each exposure
- Each instrument readout (16 total) in an HDU
- HDUs for exposure meter, guider image and coherent fiber bundle

- **Level 1 – Extracted Spectra**

- 2D FITS images (order x pixel column) with extensions for sky, calibration, science fibers, and wavelength solution



- **Level 2 – Radial Velocities**

- Cross correlation function data
- Sky and telluric models
- Activity indicators
- Additional keywords include
- Barycentric correction
- RV per order
- Drift terms

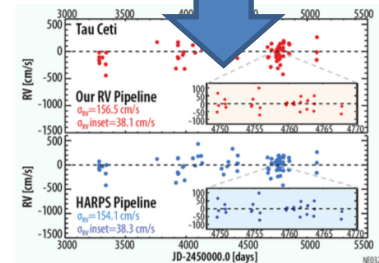
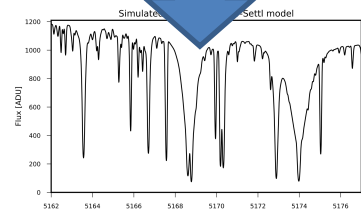

Overview of EPRV instruments

THANK YOU!

Acknowledgements:

- Paul Robertson (UCI)
- Andreas Quirrenbach (Heidelberg)
- Francesco Pepe (Geneva)
- Suvrath Mahadevan (Penn State)

