

# 100 Years of Not Finding a Planet with Astrometry

G. Fritz Benedict  
McDonald Observatory  
The University of Texas

# 100 Years of Not Finding a Planet with Astrometry

Introduction

The Early Years

van de Kamp and Barnard's Star

HST

The Value of Low-mass Binaries

The Glorious Future

Summary

# 100 Years of Not Finding a Planet with Astrometry

Introduction

# Typical response to the word

# *Astrometry*



Not anymore. 109 refereed papers with Gaia in the title since end of April.

# Astrometry and orbital motion

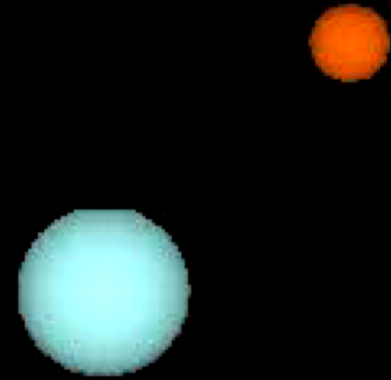

$$M_1/M_2=3.6; e=0.4$$

Astrometry, a simple example  
 5 "plates"  
 different scales  
 different orientations

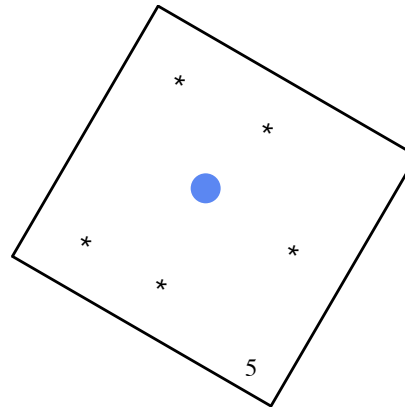
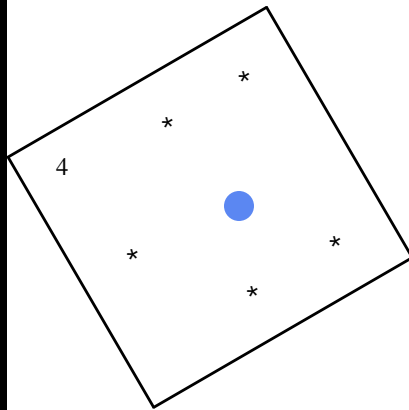
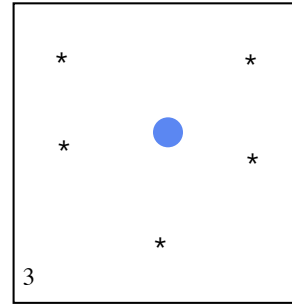
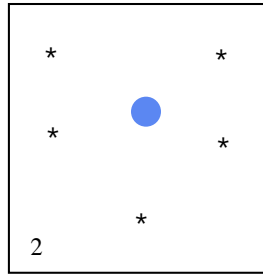
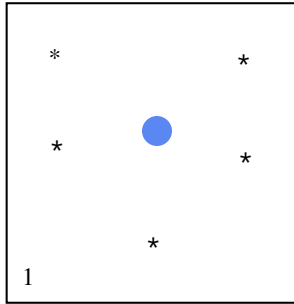

Result of Overlap  
 Solution to  
 Plate #1

Precision = standard deviation of the  
 distribution of residuals (•) from the  
 model-derived positions (\*)

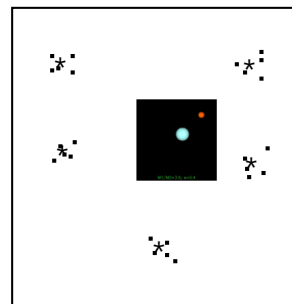

0.002 arcsec

# Star Positions to Astrometry

Modeling, scale,  
 rotation, and  
 offset

$$\xi = ax + by + c$$

$$\eta = -bx + ay + f$$

The resulting six  
 ( $\xi$ ,  $\eta$ ) pairs are a  
 catalog with  
 associated errors.  
 Also get the  
 residuals to the fit.

# 100 Years of Not Finding a Planet with Astrometry

The Early Years

The Discovery of Neptune in 1846

by Le Verrier,  
with **ASTROMETRY**

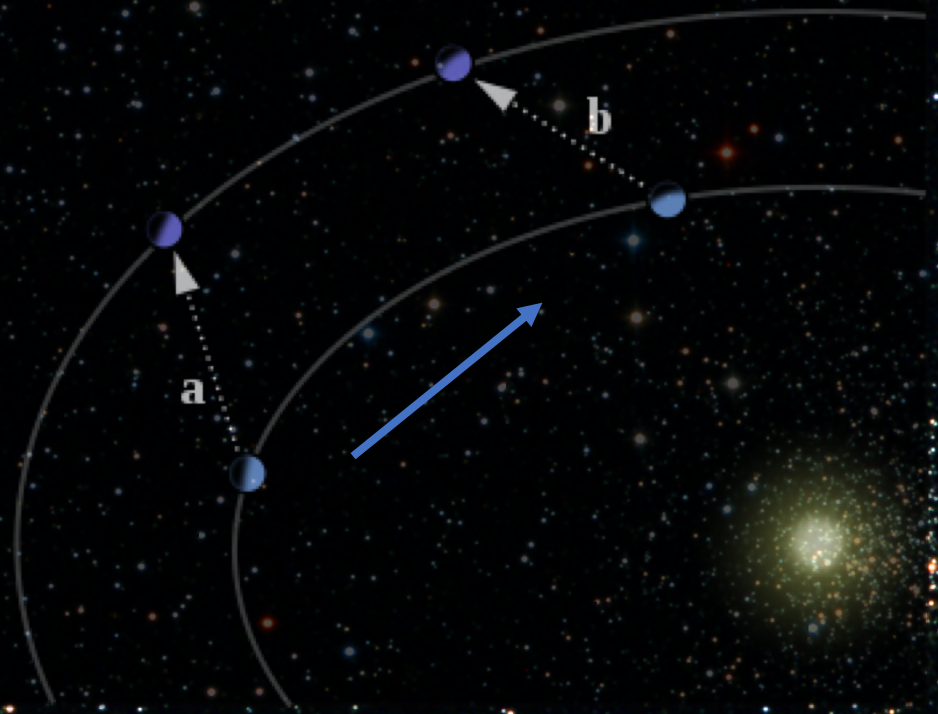



# 172 Years of Not Finding a Planet with Astrometry

van de Kamp and  
Barnard's Star



# 50 & 25 YEARS AGO



*June 1944*

As if to commemorate the 100th anniversary of Bessel's prediction that Sirius has a companion, Dr. Peter van de Kamp, director of Sproul Observatory, has reported . . . his new discovery of unseen companions of two nearby stars which have heretofore been considered single. Barnard's star, of greatest known motion across the face of the sky, is one of the stars, and the other is Lalande 21185; they are, respectively, the second and (probably) third nearest stars to the sun.



*June 1969*

Now Dr. van de Kamp points out an alternative interpretation of the observations. The measured [proper motion] deviations of Barnard's star may result from perturbations by *two* unseen companions, revolving in approximately coplanar circular orbits with periods of 26 and 12 years.

*The confirmation of planets or minisuns circling Barnard's Star has not yet been made. Omitting the Sun, Barnard's Star is the fourth closest (after the three members of the Alpha Centauri system); Lalande 21185 is the sixth.*

From *Sky and Telescope*,  
1994

What's  
your  
hurry?

**50 & 25**  
**YEARS AGO**



**June 1944**

As if to commemorate the 100th anniversary of Bessel's prediction that Sirius has a companion, Dr. Peter van de Kamp, director of Sproul Observatory, has reported . . . his new discovery of unseen companions of two nearby stars which have heretofore been considered single. Barnard's star, of greatest known motion across the face of the sky, is one of the stars, and the other is Lalande 21185; they are, respectively, the second and (probably) third nearest stars to the sun.



**June 1969**

Now Dr. van de Kamp points out an alternative interpretation of the observations. The measured [proper motion] deviations of Barnard's star may result from perturbations by *two* unseen companions, revolving in approximately coplanar circular orbits with periods of 26 and 12 years.

*The confirmation of planets or minisuns circling Barnard's Star has not yet been made. Omitting the Sun, Barnard's Star is the fourth closest (after the three members of the Alpha Centauri system); Lalande 21185 is the sixth.*

# 172 Years of Not Finding a Planet with Astrometry

Investigations at observatories other than Sproul, however, failed to confirm the existence of a perturbation in the Barnard's star path (Gatewood and Eichhorn 1973; Fredrick and Ianna 1985; Harrington and Harrington 1987). Infrared, speckle, and radial velocity searches of Barnard's star similarly have been negative (e.g. Skrutskie, Forrest, and Shure 1989; Henry and McCarthy 1990; Marcy and Benitz 1989).

P. A. Ianna, 1995, *Ap&SS*, 223, 161

# 172 Years of Not Finding a Planet with Astrometry

HST



HST lets us measure angles with millisecond of arc precision, a quarter 1500 miles away.



S125E011810

HUBBLE SPACE TELESCOPE FIELD OF VIEW  
POST-SM3B CONFIGURATION

# HST Focal Plane

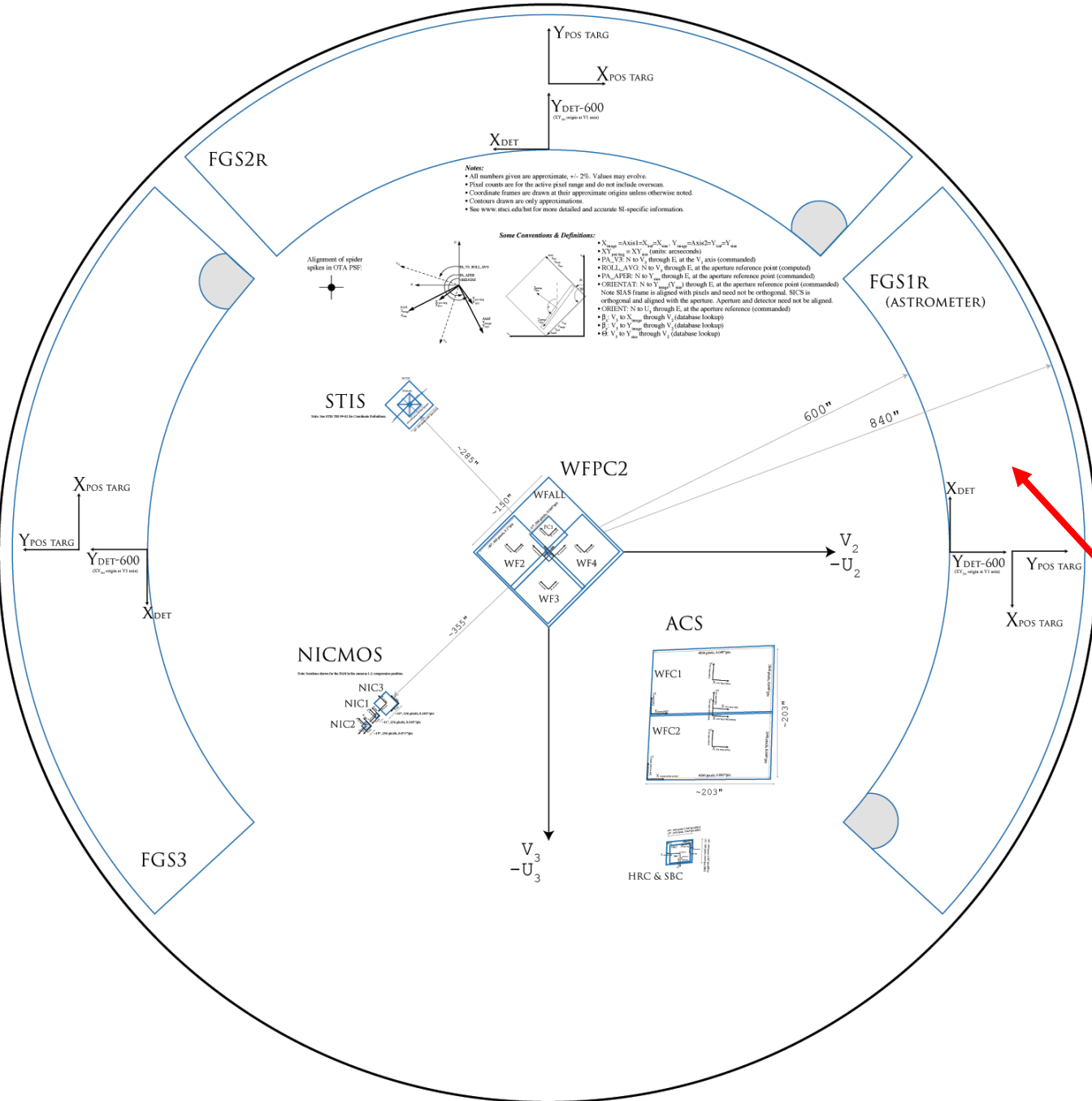

# Space Astrometry with an Interferometer on Hubble Space Telescope

The Koester's Prism - the Interferometric Heart of a Fine Guidance Sensor (FGS)

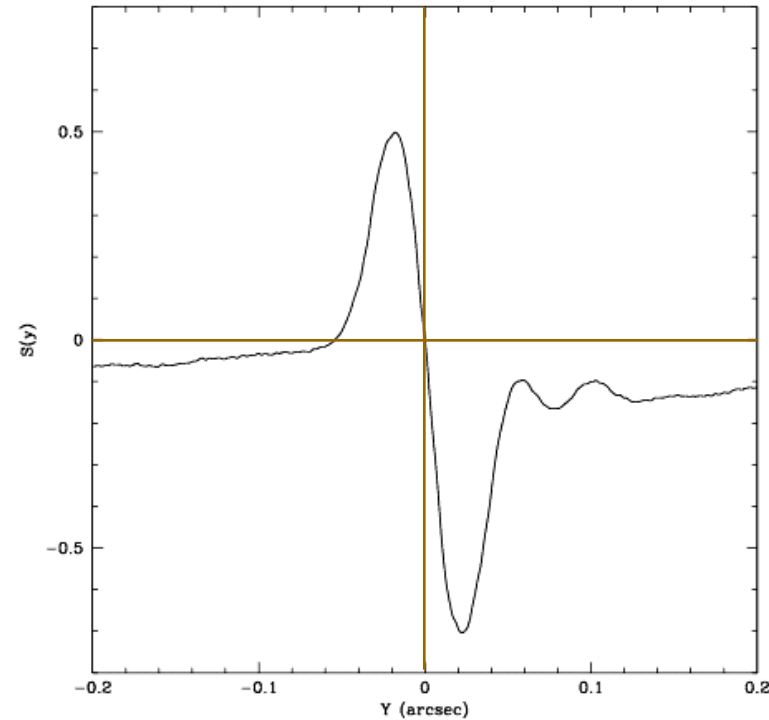
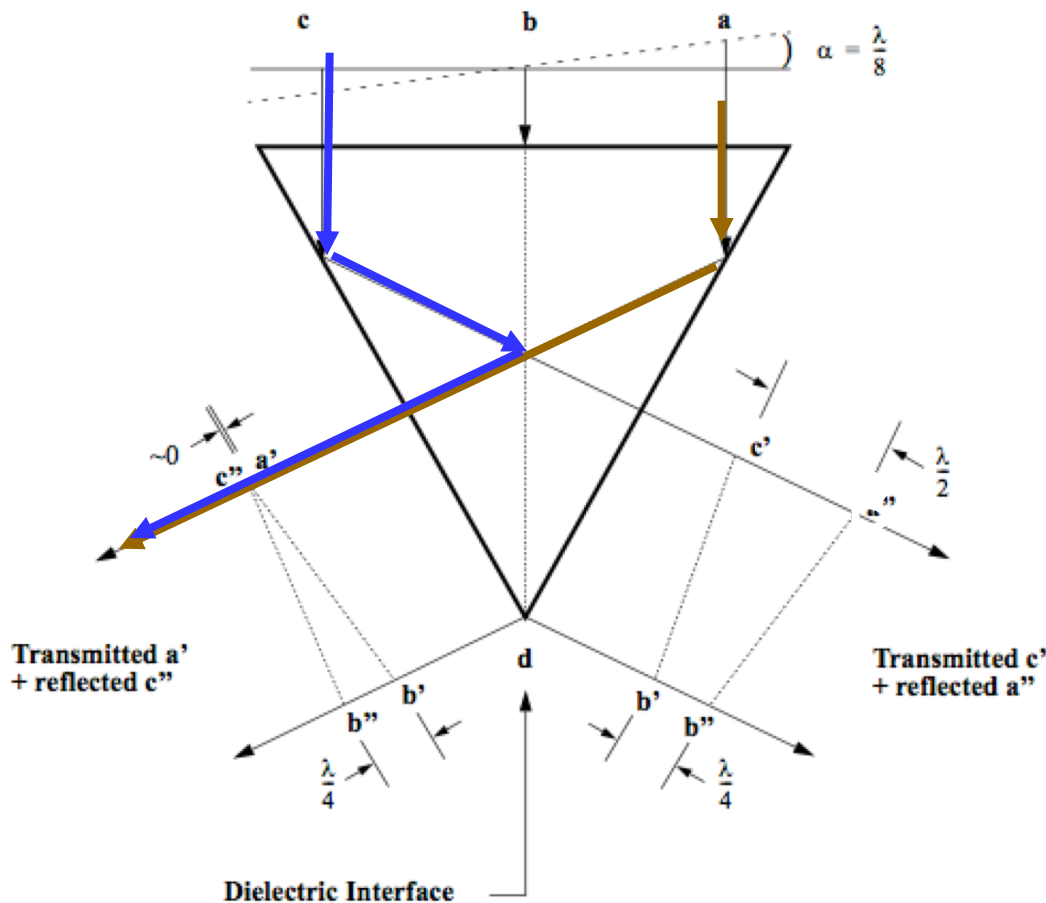

$$S = (A-B)/(A+B)$$

Effectively, a 2.4m baseline interferometer



TABLE 7  
PARALLAX AND PROPER MOTION

Parameter	Proxima Cen	Barnard's Star
<i>HST</i> study duration .....	5.6 yr	3.3 yr
Observation sets .....	59	34
Reference stars' $\langle V \rangle$ .....	14.5	14.2
Reference stars' $\langle B - V \rangle$ .....	+0.87	+0.85
Relative parallax .....	$767.7 \pm 0.2$ mas	$544.2 \pm 0.2$ mas
Correction to absolute .....	$1.0 \pm 0.2$ mas	$1.2 \pm 0.2$ mas
<i>HST</i> absolute parallax .....	$768.7 \pm 0.3$ mas	$545.4 \pm 0.3$ mas
Yale parallax catalog <sup>a</sup> .....	$769.8 \pm 6.1$ mas	$545.6 \pm 1.3$ mas
<i>Hipparcos</i> parallax .....	$772.3 \pm 2.4$ mas	$549.3 \pm 1.6$ mas
<i>HST</i> proper motion .....	$3851.7 \pm 0.1$ mas yr <sup>-1</sup>	$10370.0 \pm 0.3$ mas yr <sup>-1</sup>
In P.A. ....	$78^{\circ}46 \pm 0^{\circ}03$	$4^{\circ}45 \pm 0^{\circ}1$
<i>HST</i> secular acceleration .....	...	$12 \pm 4$ mas yr <sup>-2</sup>
<i>Hipparcos</i> proper motion .....	$3852.9 \pm 2.3$ mas yr <sup>-1</sup>	$10368.6 \pm 2.1$ mas yr <sup>-1</sup>
In P.A. ....	$78^{\circ}50 \pm 0^{\circ}03$	$4^{\circ}42 \pm 0^{\circ}07$

<sup>a</sup> Van Altena et al. 1995.

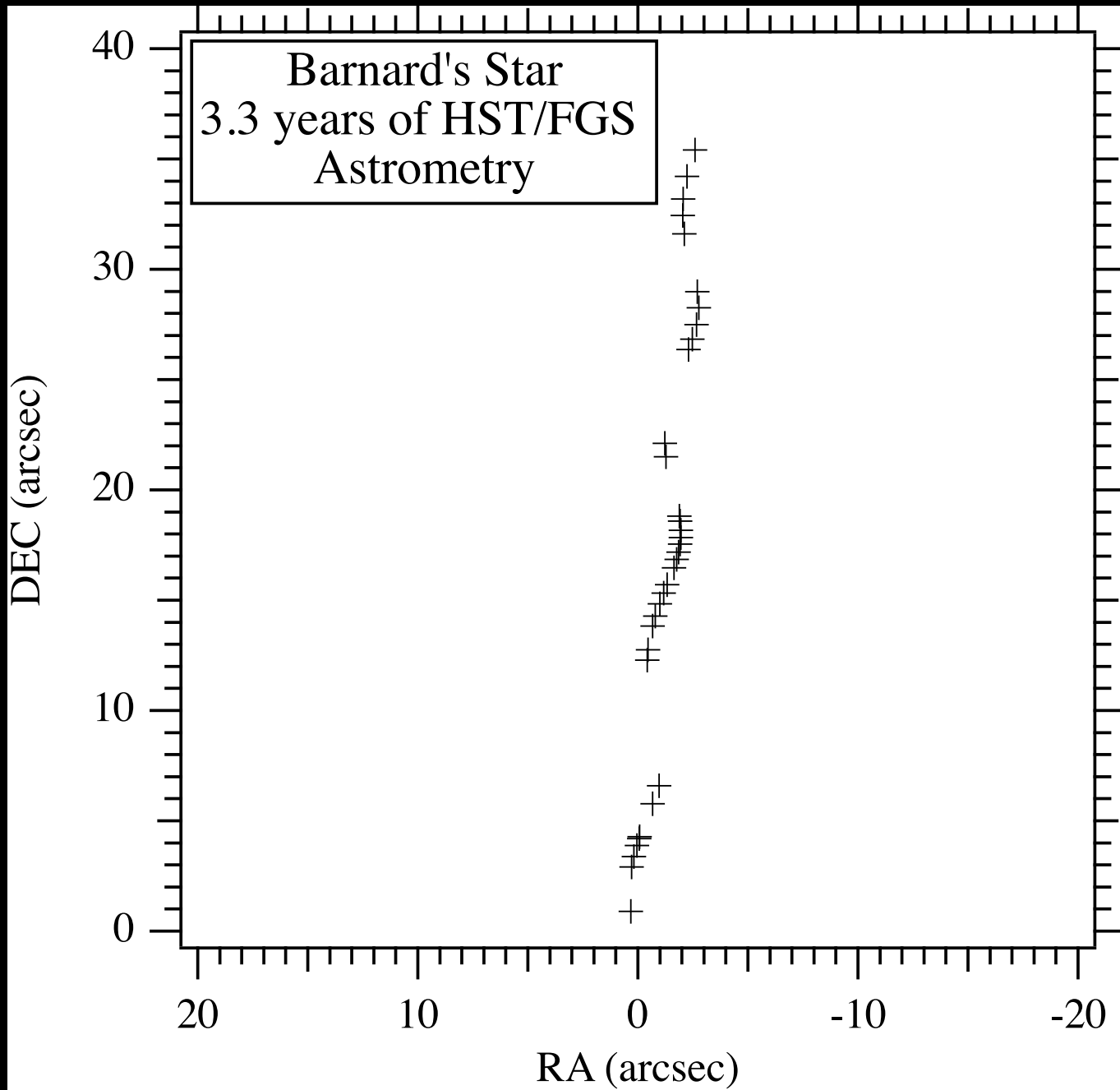

FOR WITH SLIGHT EFFORTS, HOW SHOULD

ONE OBTAIN GREAT RESULTS? IT IS

FOOLISH EVEN TO DESIRE IT.

- EURIPIDES

**The first principle is that you must not fool  
yourself - and you are the easiest person to fool.**

**- R. Feynman**

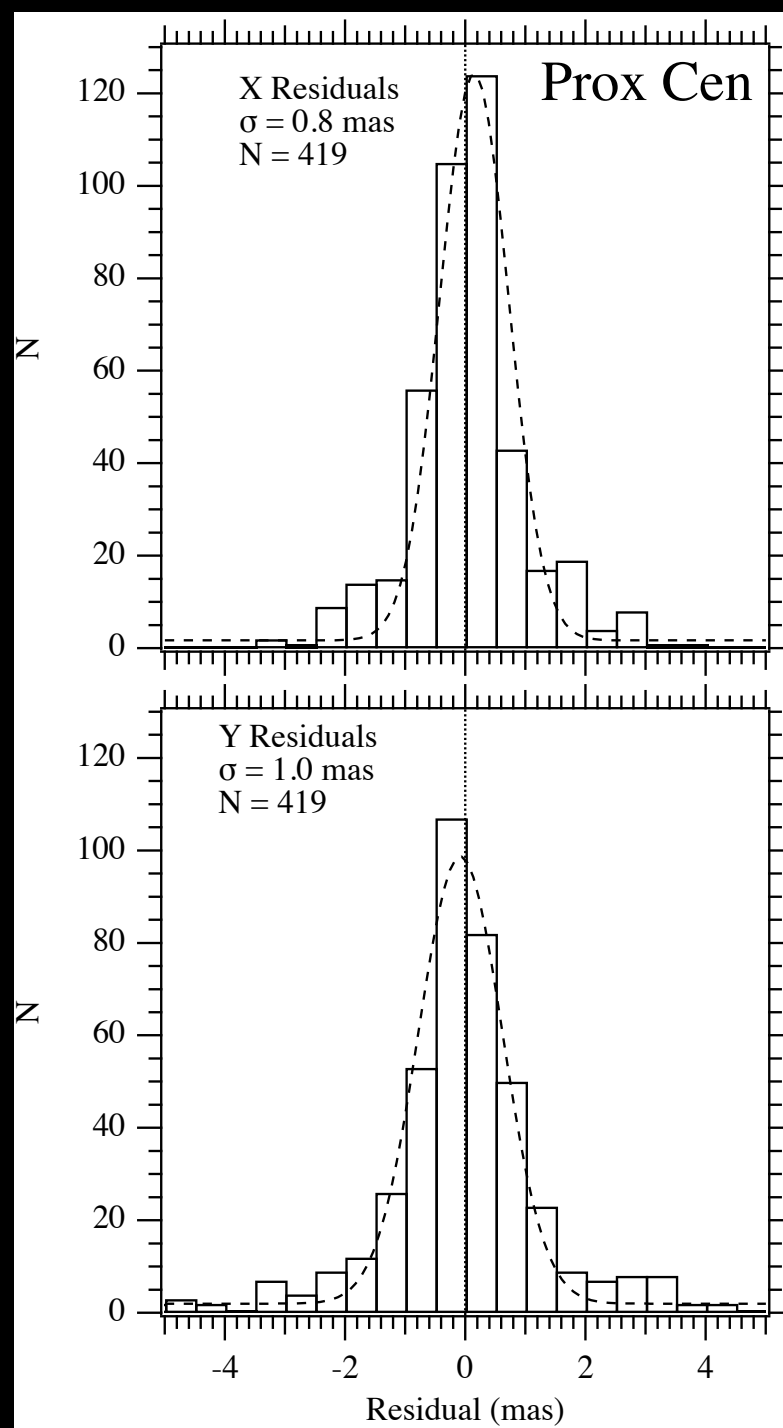

We missed this one.\*  
No shame.  
Would require 1  $\mu$ asec  
measurement  
precision, not  
the 1 mas we had.

\*Anglada-Escude, 2016, Nature, 536, 437  
RV detection

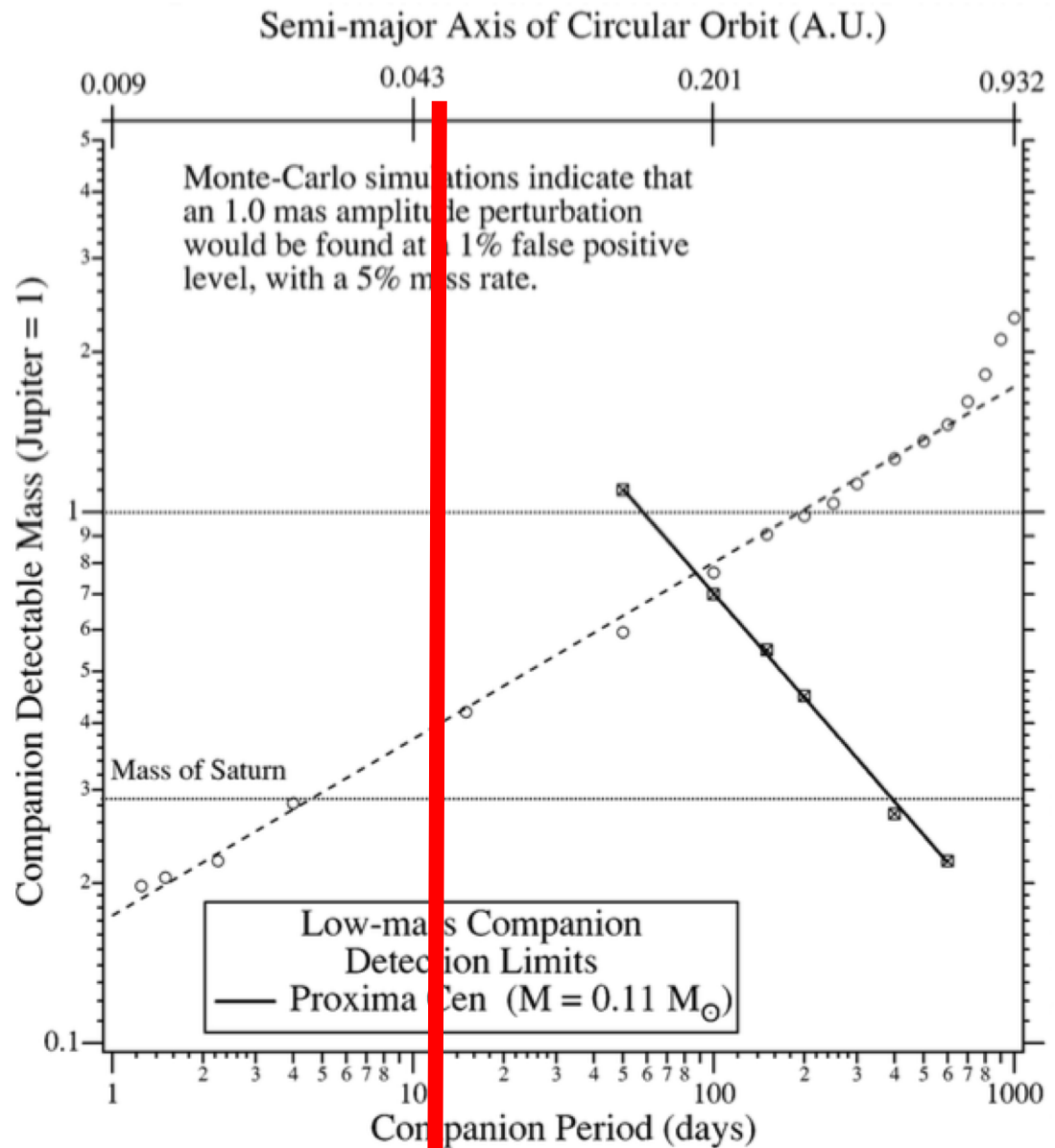

FIG. 17.—Same as Fig. 16, but for Proxima Cen. Monte Carlo simulations indicate that a 1.0 mas amplitude perturbation would be found at a 1% false-positive level, with a 5% miss rate. The dashed line presents the limits determined by the radial velocity program of Kürster et al. (1999).

## Tasting Note by The Producer

**Nose:** Lots of fruit with a mixture of grapefruit peel, dried tropical fruits, wine gums and a touch of cassis.

**Palate:** Orange peel, honeycomb, brandy snaps, black pepper and tobacco leaf.

**Finish:** Mineral notes combining with fennel, tea leaf and leather against a background of soft burning embers.

... the dregs of my hopes having gone up in flames ...



# What We\* Did Not FIND, but Measure

HST/FGS Exoplanetary Astrometric Results									
<u>Companion</u>	<u>M*</u> (M <sub>⊙</sub> )	<u>[Fe/H]</u>	<u>Sp.T.</u>	<u>d(pc)</u>	<u>ecc</u>	<u>M (M<sub>Jup</sub>)</u>	<u>α(mas)</u>	<u>inc(°)</u>	<u>P(d)</u>
υ And c	1.31	+0.15	F8 V	13.5	0.25	14 ± 4	0.62	8±1	241
υ And d					0.32	10 ± 2	1.4	24±1	1282
GJ 876 b	0.32	+0.17	M4 V	4.7	0.1	1.9±0.5	0.25	84±6	61
55 Cnc d	1.21	+0.32	G8 V	12.5	0.33	4.9±1.1	1.9	53±7	4517
ε Eri b	0.83	-0.03	K2 V	3.2	0.7	1.6±0.2	1.9	30±4	2502
HD 33636 B	1.02	-0.13	G0 V	28.1	0.48	142±11	14.2	4.0±0.1	2117
HD 136118 b	1.24	-0.01	F9 V	52.3	0.35	42±15	1.5	163±3	1191
HD 38529 c	1.48	+0.27	G4 IV	40.0	0.36	17.6±1.4	1.1	48±4	2136
HD 128311 c	0.83	+0.2	K0 V	16.5	0.154	3.8±0.7	0.5	56±14	922
HD 202206 B	1.07	+0.35	G6V	45.5	0.432	94±7	18.2	11±1	256
HD 202206 c					0.22	17.9±2	52.9	8±1	1260
γ Cep Ab	1.18	0	K1 III-IV	13.5	0.4	9.4±1	1.1	170±1	905

\*Benedict, McArthur, Harrison, Martioli, Bean

# A Triumph - Architecture of the $\upsilon$ And System (Analysis by Barbara McArthur)

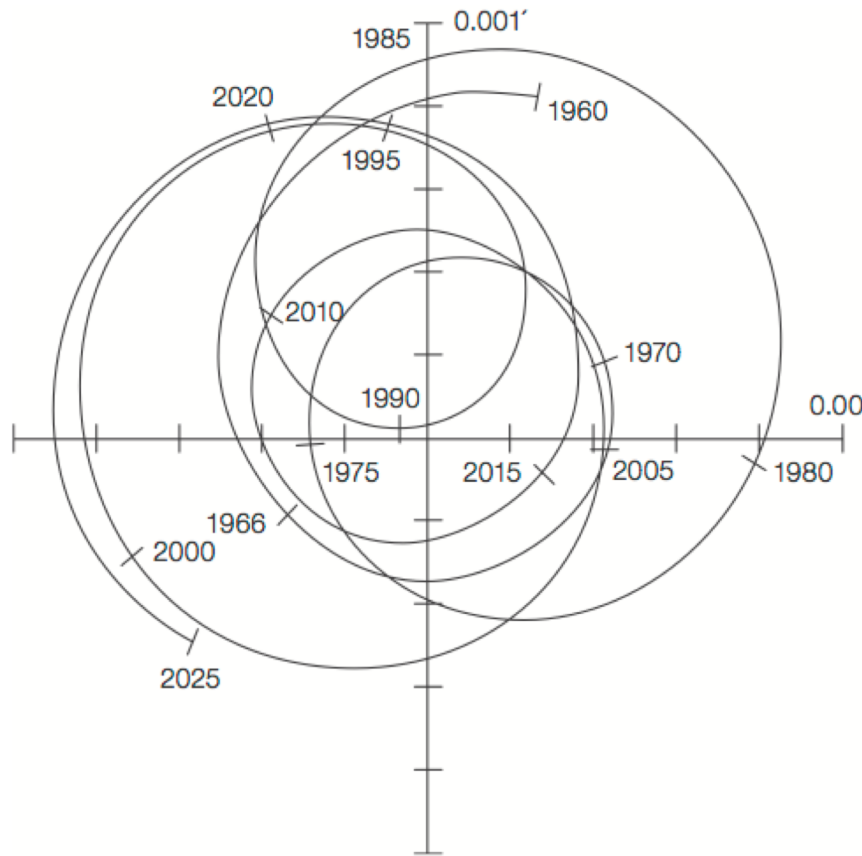

$\upsilon$  And like ours?

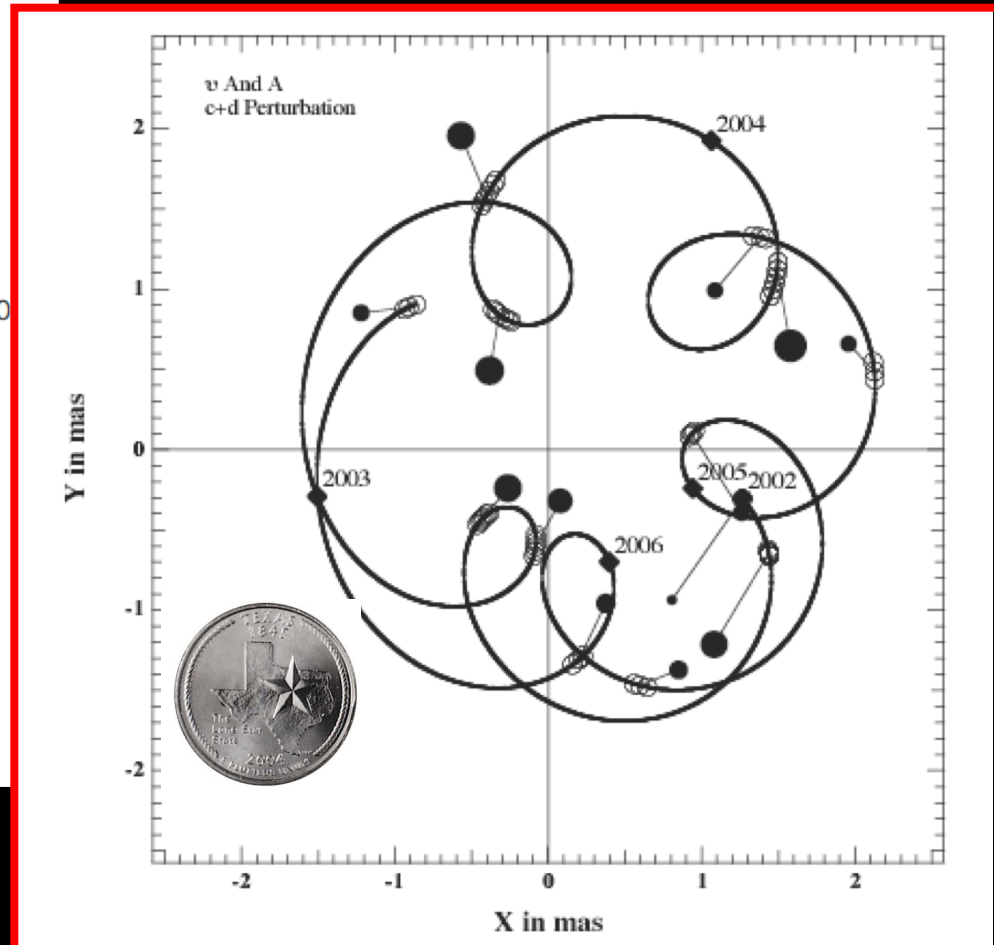



# υ And system not so much like ours

What could have  
'screwed up' the υ And  
system?

The migration of this  
hot Jupiter

...

... and/or this distant  
companion is not always  
so distant?

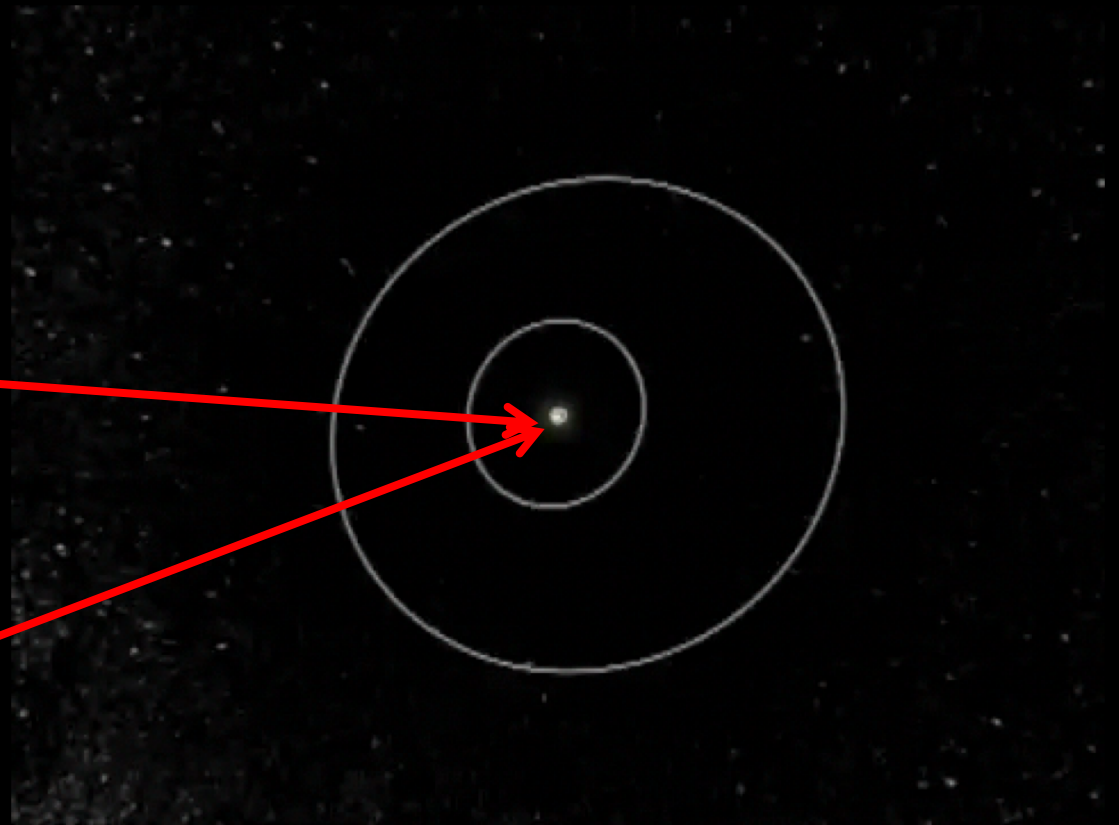

# Another System Dissected

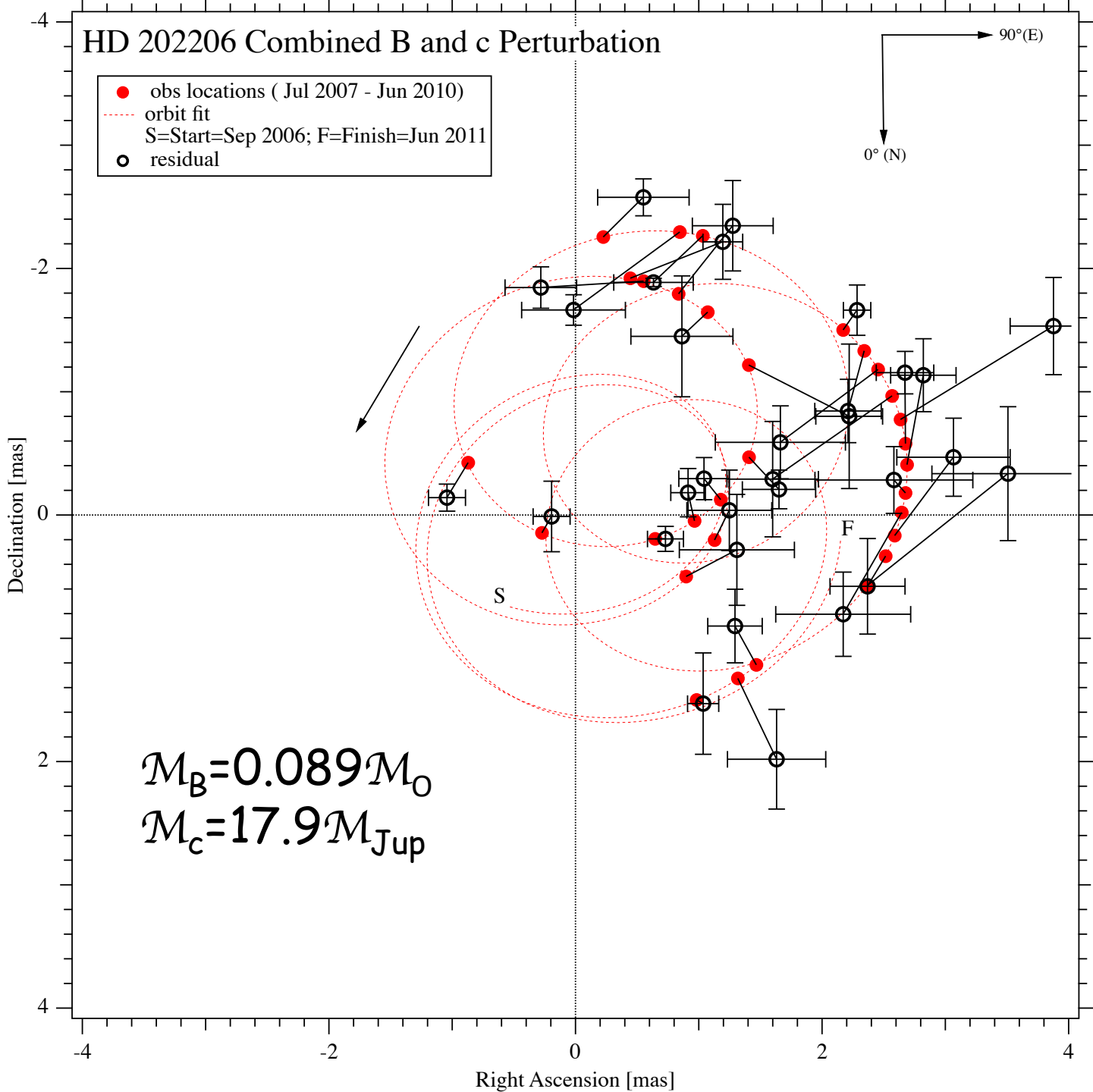

# HD 202206 System Nearly Coplanar

THE ASTRONOMICAL JOURNAL, 153:258 (12pp), 2017 June

Benedict & Harrison

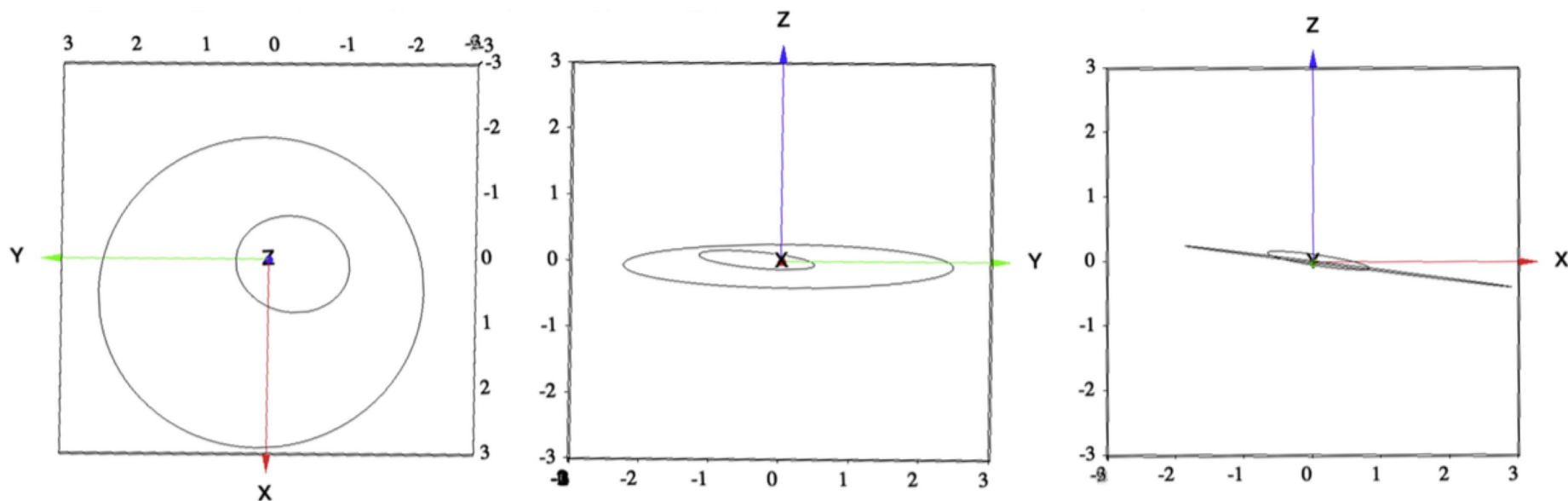

**Figure 10.** Component *B* (inner) and *c* (outer) orbits as observed (left to right panels) toward the  $-z$  (looking at the HD 202206 system with  $+y$  to the south and  $+x$  pointing west), toward  $-x$  (east in R.A.), and  $-y$  (north in decl.) axes. Axes units are au.

# What We\* Did Not FIND, but Measure

HST/FGS Exoplanetary Astrometric Results									
<u>Companion</u>	<u>M*</u> (M <sub>⊙</sub> )	<u>[Fe/H]</u>	<u>Sp.T.</u>	<u>d(pc)</u>	<u>ecc</u>	<u>M (M<sub>Jup</sub>)</u>	<u>α(mas)</u>	<u>inc(°)</u>	<u>P(d)</u>
υ And c	1.31	+0.15	F8 V	13.5	0.25	14 ± 4	0.62	8±1	241
υ And d					0.32	10 ± 2	1.4	24±1	1282
GJ 876 b	0.32	+0.17	M4 V	4.7	0.1	1.9±0.5	0.25	84±6	61
55 Cnc d	1.21	+0.32	G8 V	12.5	0.33	4.9±1.1	1.9	53±7	4517
ε Eri b	0.83	-0.03	K2 V	3.2	0.7	1.6±0.2	1.9	30±4	2502
HD 33636 B	1.02	-0.13	G0 V	28.1	0.48	142±11	14.2	4.0±0.1	2117
HD 136118 b	1.24	-0.01	F9 V	52.3	0.35	42±15	1.5	163±3	1191
HD 38529 c	1.48	+0.27	G4 IV	40.0	0.36	17.6±1.4	1.1	48±4	2136
HD 128311 c	0.83	+0.2	K0 V	16.5	0.154	3.8±0.7	0.5	56±4	922
HD 202206 B	1.07	+0.35	G6V	45.5	0.432	94±7	18.2	11±1	256
HD 202206 c					0.22	17.9±2	52.9	8±1	1260
γ Cep Ab	1.18	0	K1 III-IV	13.5	0.4	9.4±1	1.1	170±1	905

\*Benedict, McArthur, Harrison, Martioli, Bean

# SCARCE Astrometry and Discovery (and follow-up RV) tied together through this constraint

$$\frac{\alpha_A \sin i}{\pi_{\text{abs}}} = \frac{PK_A \text{sqrt}(1 - e^2)}{2\pi \times 4.7405}$$

Pourbaix & Jorissen, 2000, A&A 145, 161

# 172 Years of Not Finding a Planet with Astrometry

Astrometry can Assist the Exoplanet Game in  
Other Ways

Low-mass Binaries and the Lower Main  
Sequence Mass-Luminosity Relation

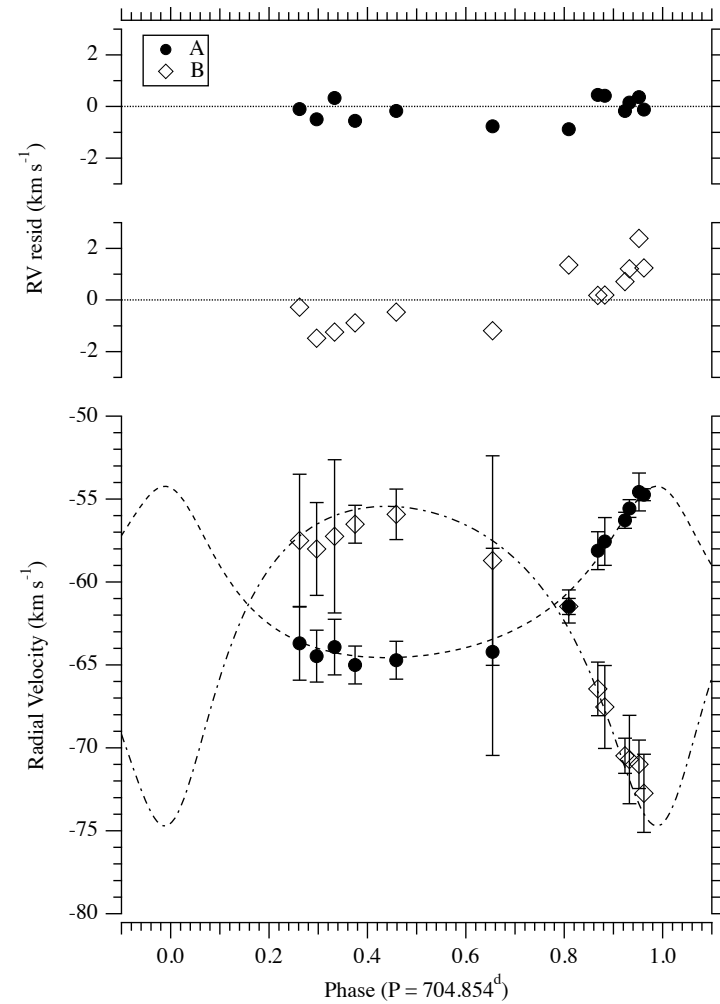
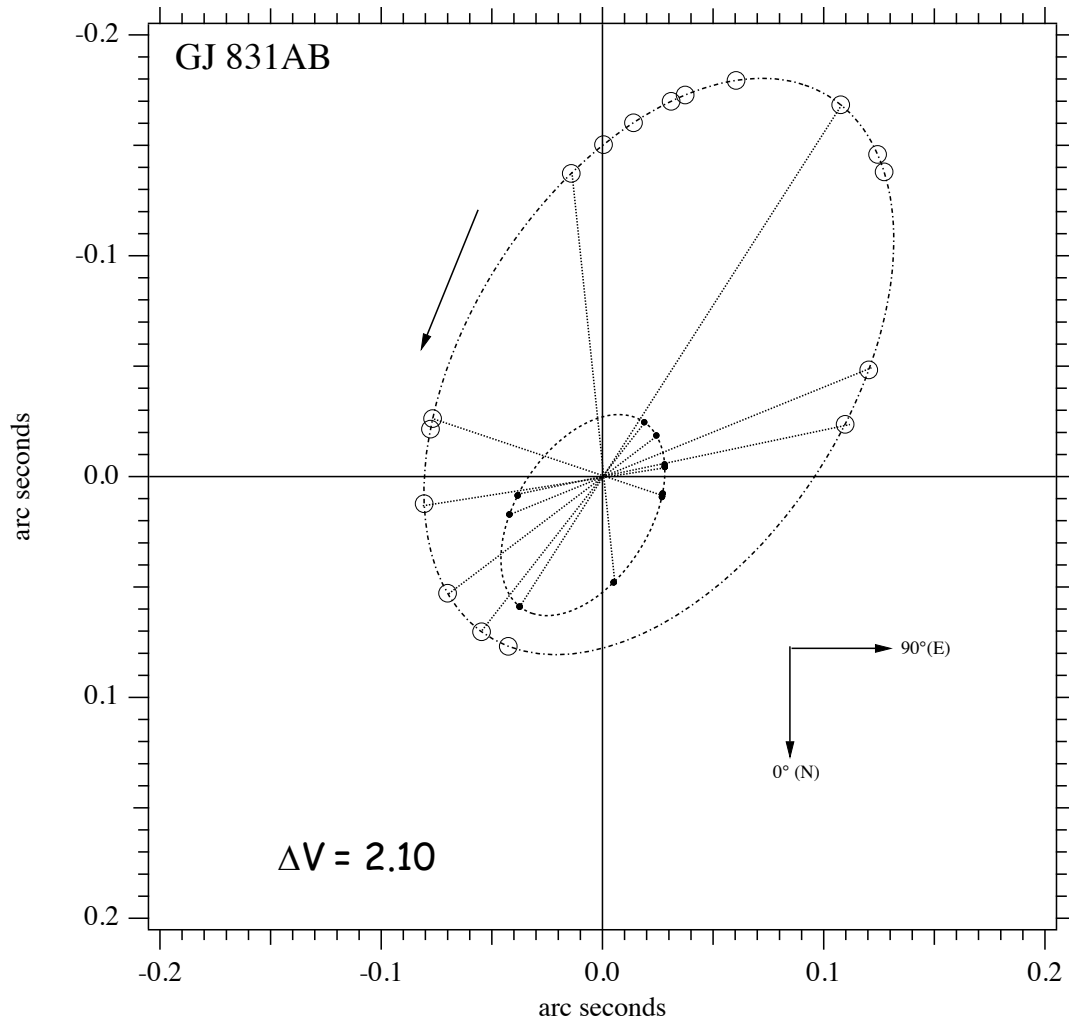

Left: GJ 831A (dots, POS orbit predicted positions) and component B (open circles, TRANS orbit predicted positions). All observations, POS and TRANS and A and B component radial velocities, were used to derive the final orbital elements. POS and TRANS astrometric residuals are smaller than the symbols. The arrow indicates the direction of orbital motion.

Right: RV measurements from the CE, phased to the orbital period determined from a combined solution including astrometry and RV. We obtain an absolute parallax  $\pi_{\text{abs}} = 125.3 \pm 0.3$  mas, yielding  $M_A = 0.270 \pm 0.004 M_{\odot}$  and  $M_B = 0.145 \pm 0.002 M_{\odot}$ . Mass error  $\sim 1.5\%$

Again, Astrometry and RV tied together  
through  
this constraint

$$\frac{\alpha_A \sin i}{\pi_{\text{abs}}} = \frac{PK_A \text{sqrt}(1 - e^2)}{2\pi \times 4.7405}$$

Pourbaix & Jorissen, 2000, A&A 145, 161



# M dwarf Mass-Luminosity Relationship

Benedict et al. 2016, *AJ*, 152, 141

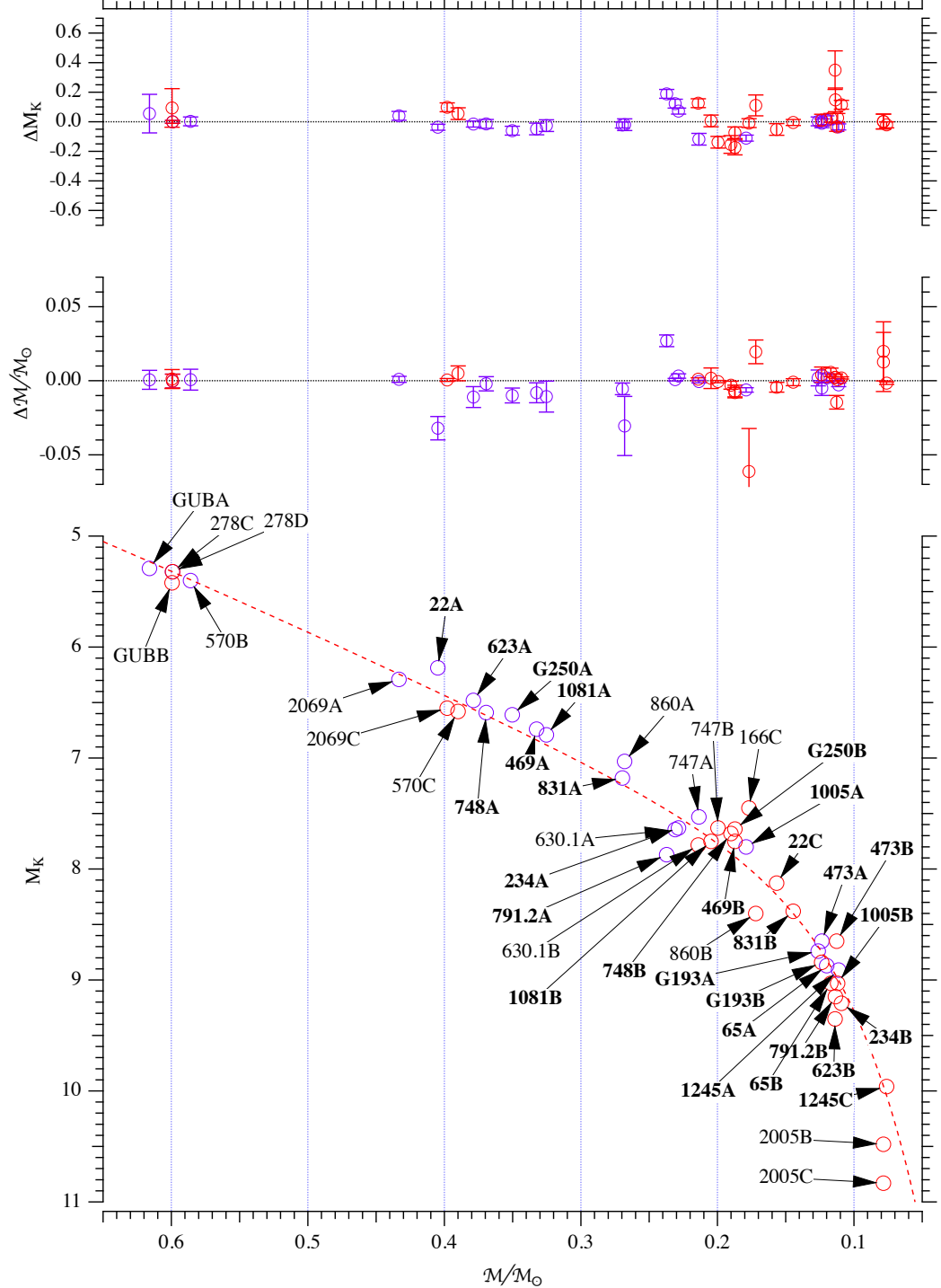

Where do we get most  $\Delta K$ ?  
Gemini AO.

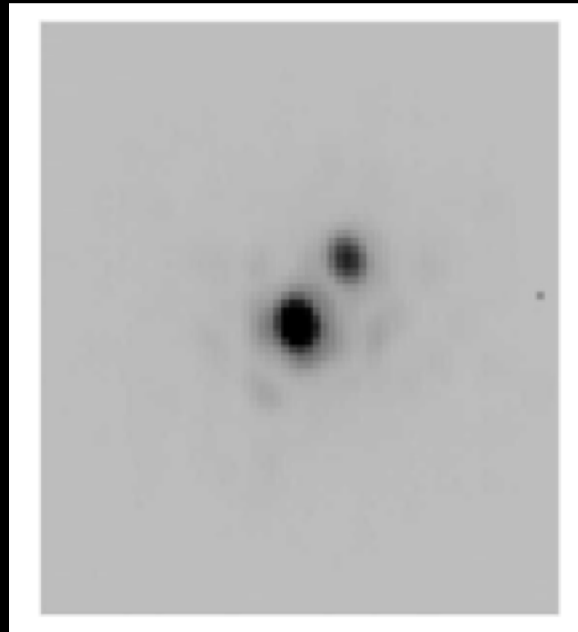

Dieterich, S., Ph. D. Thesis 2012 GSU and  
Dieterich+ 2012 AJ, 144, 64

Also Henry & McCarthy 1993 (!)

172 Years of Not Finding a Planet  
with Astrometry

The Glorious Future

This is DEAD



St

rometry

ission

# SIM and GAIA - Exo-Planet Detection Capability

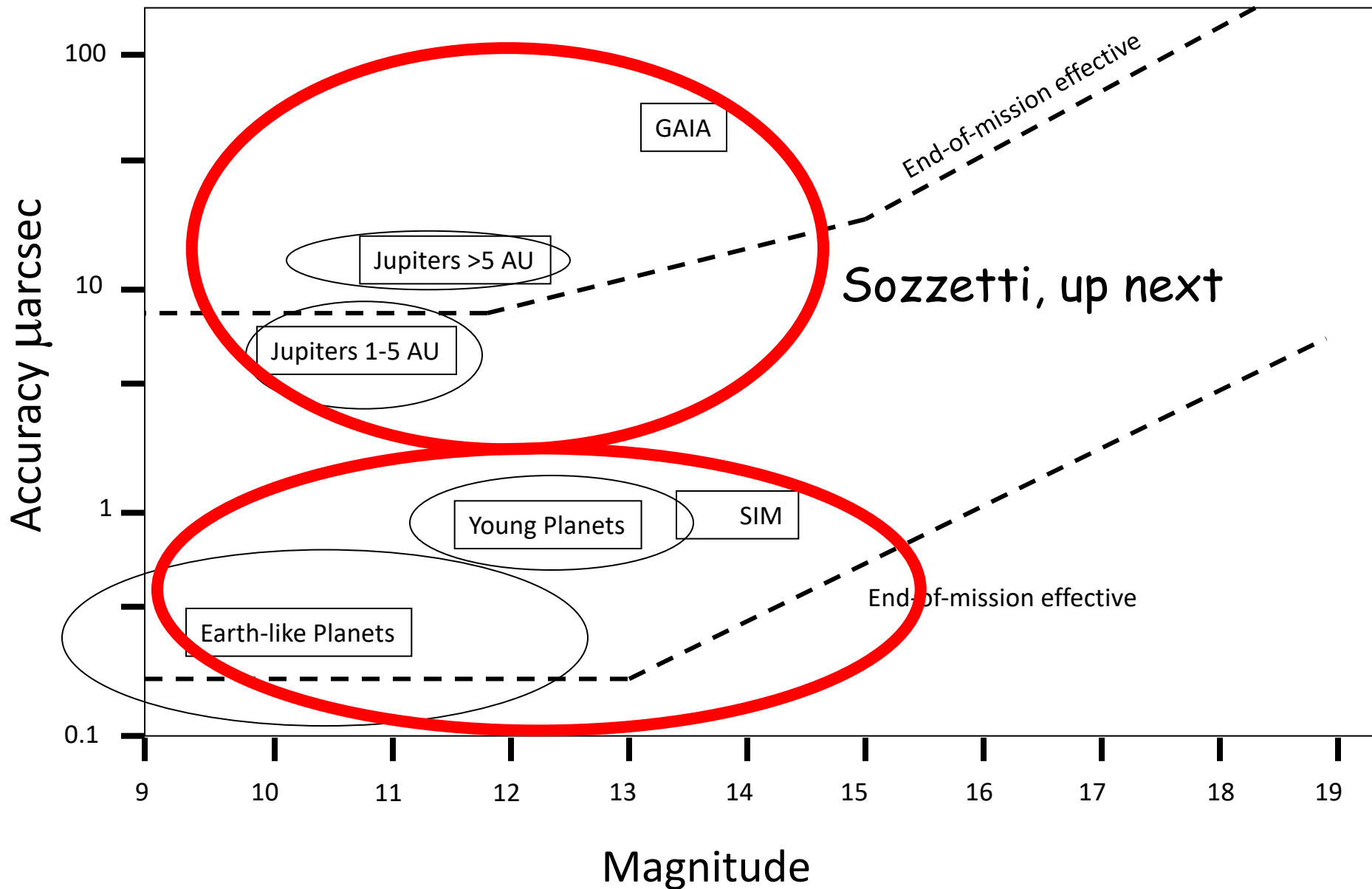

# Gaia Passes My Test

Benedict+ 2018 Res. Notes AAS 2, 22

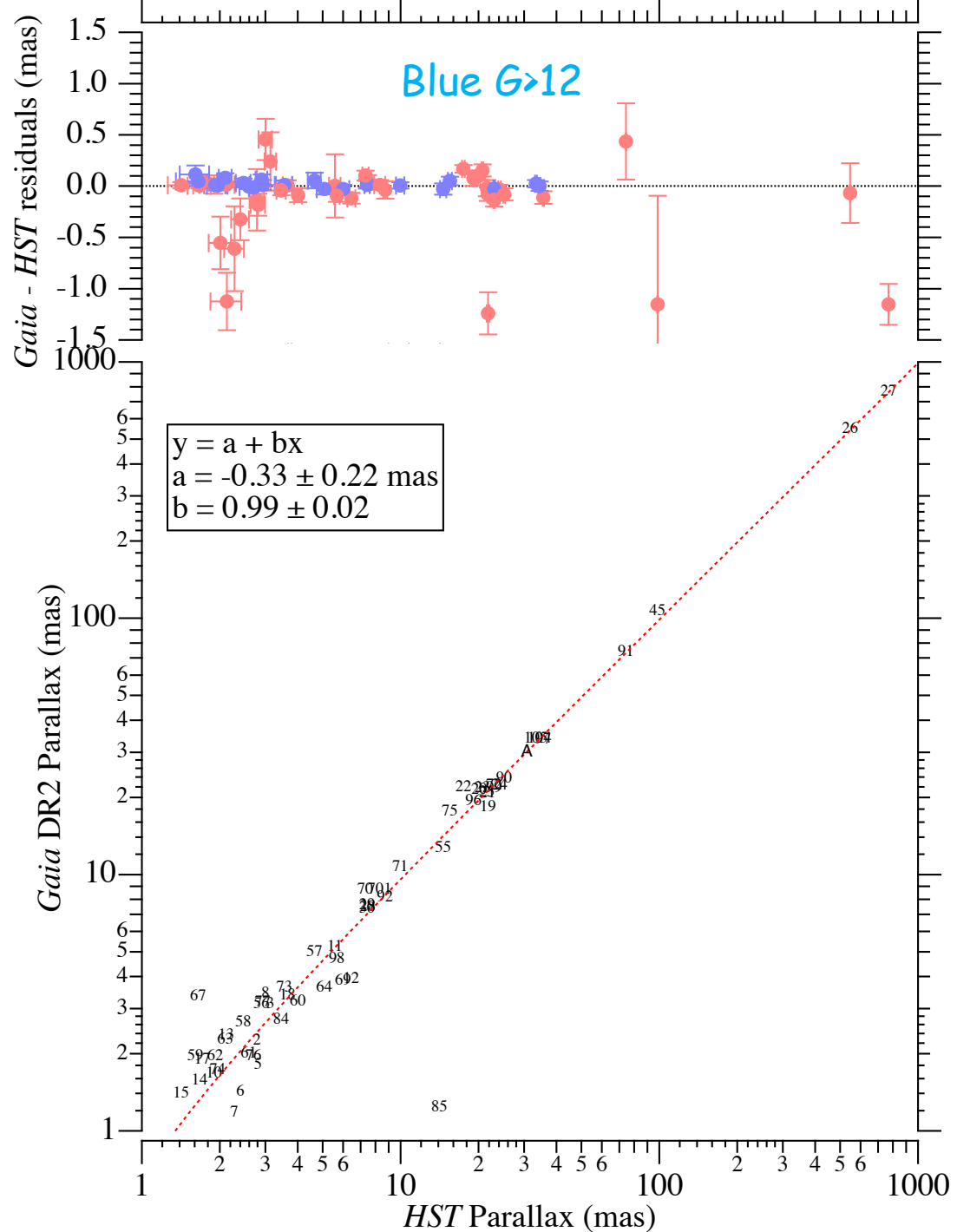

# SIM and GAIA - Exo-Planet Detection Capability

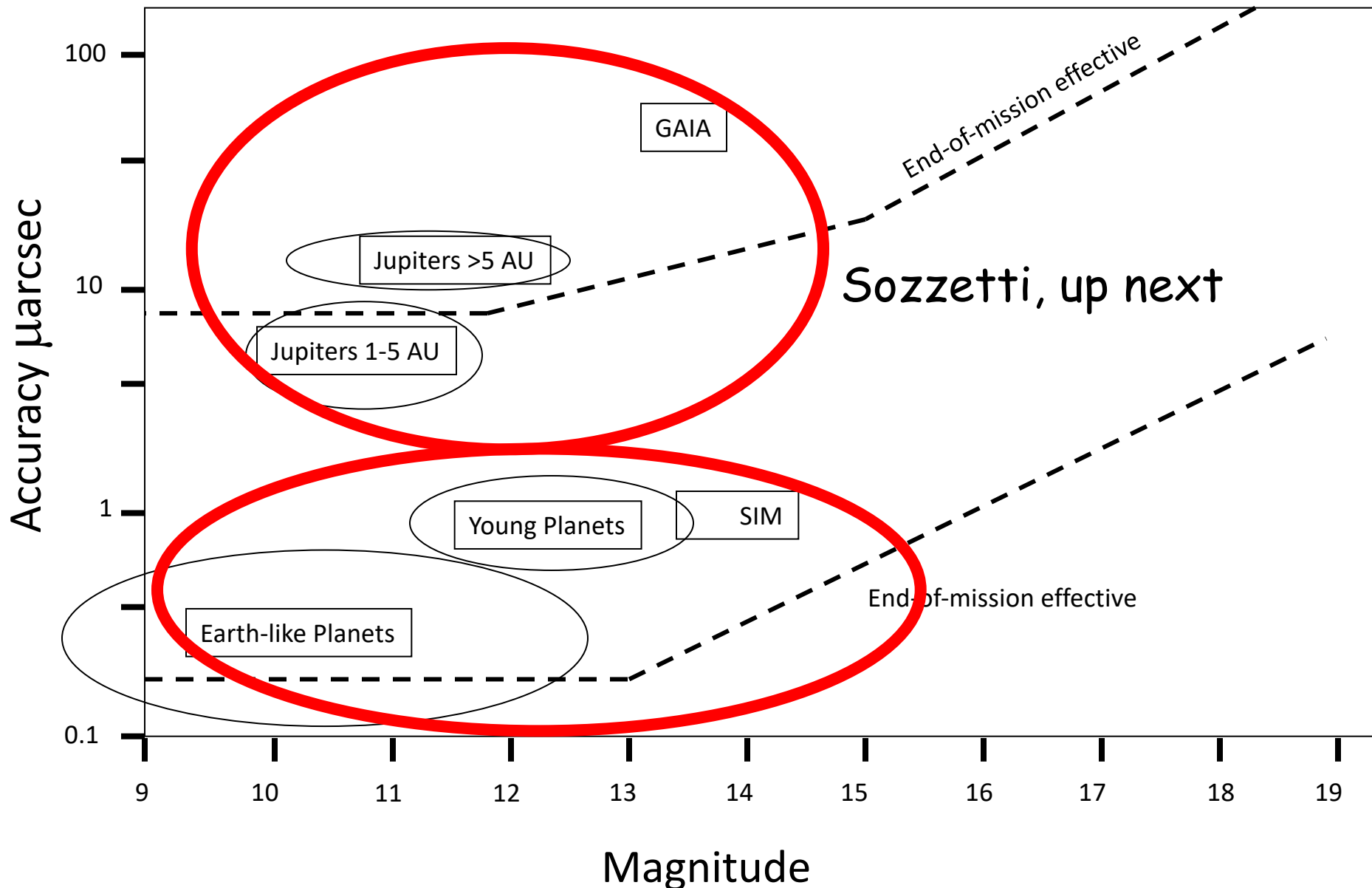

Theia



A New Hope?

ESA and Japan?



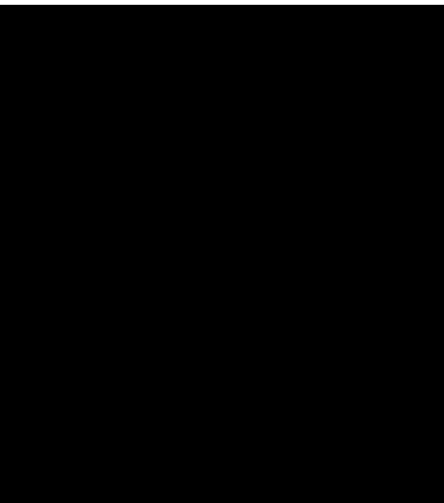
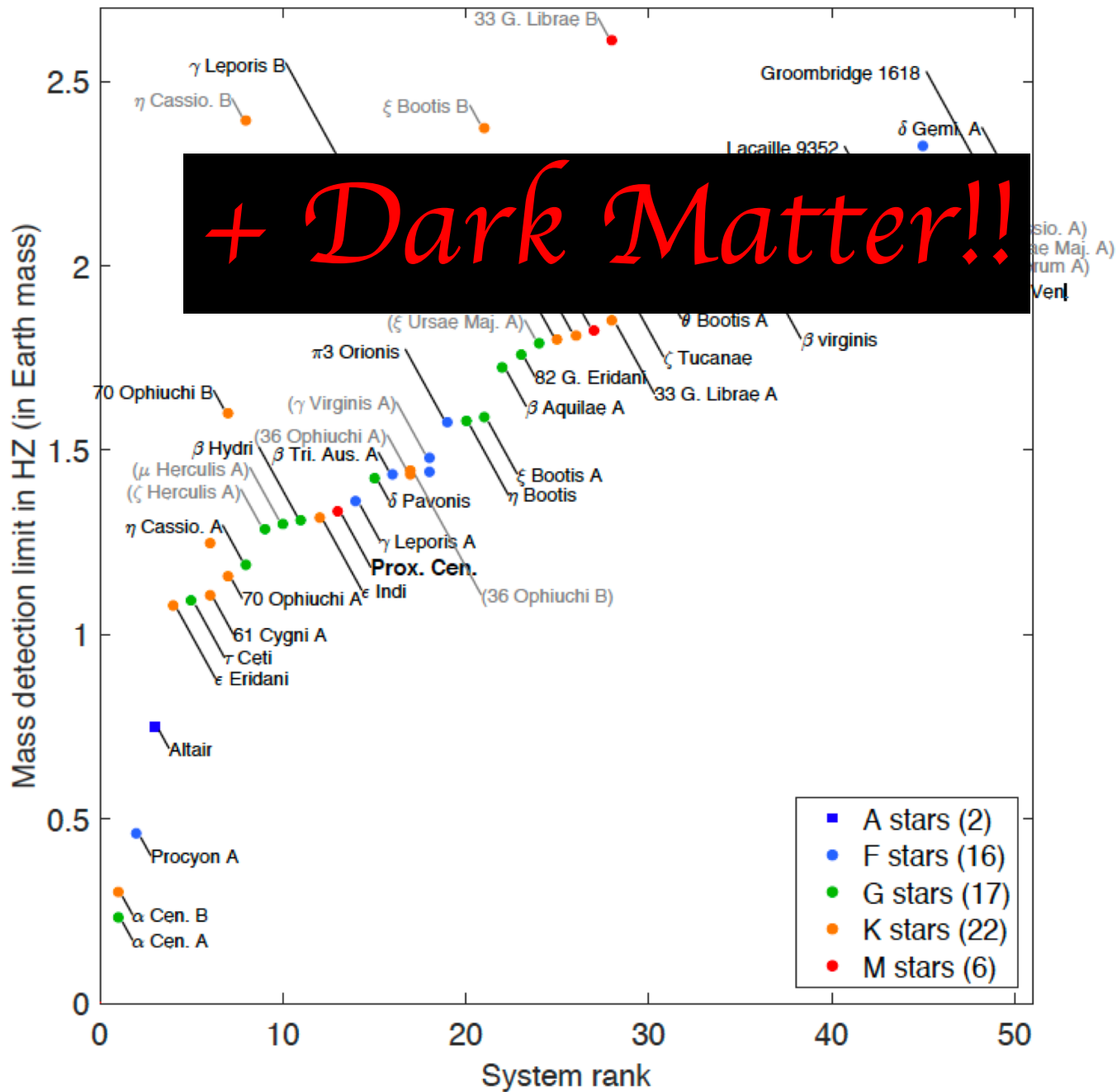

Earths and super-E  
be detected and ch

All Super-Earths v  
can be detected at  
stars.



# Independent Linear Interferometers

Lesson from Gaia (and HST/FGS): monitor, monitor, monitor

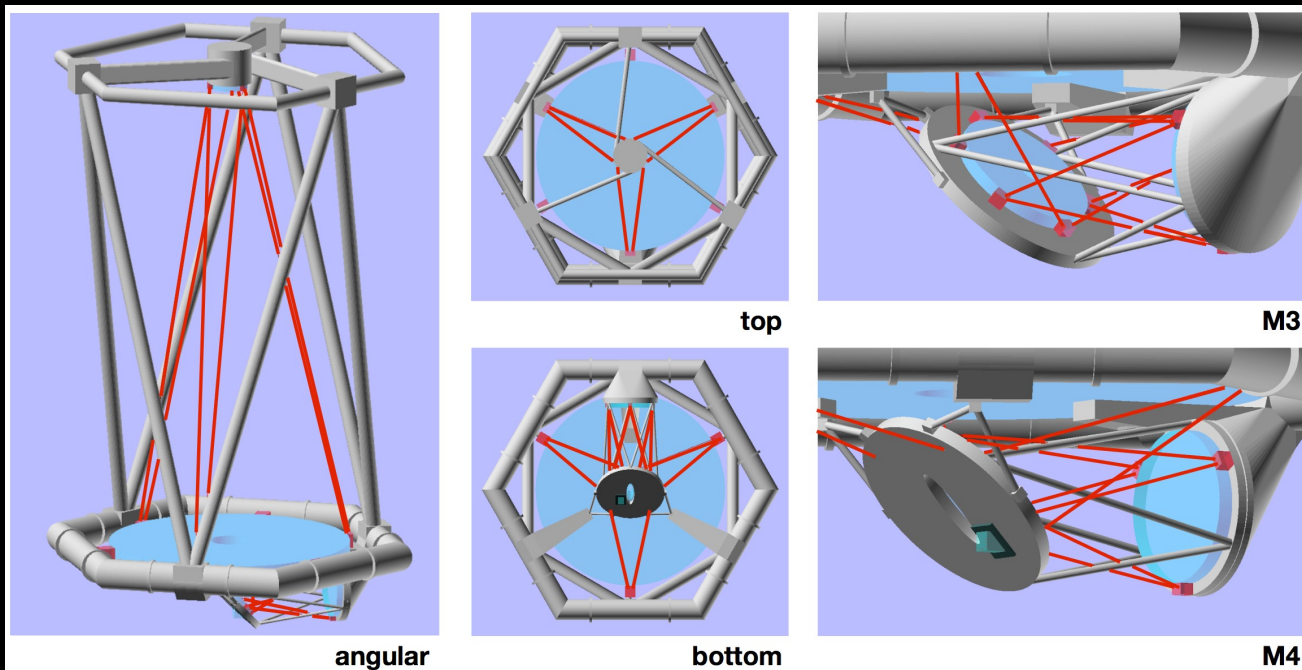

Independent linear interferometers : monitoring for corrections on ground. In red all the independent baselines forming laser hexapods. Retroreflectors are at M2 and M3. Microinterferometers at M1 and M4.

Funding an issue to be resolved ~December 2018



# An Astrometric Search for Planets Orbiting in the Alpha Centauri System

None Assigned

## ABSTRACT

We propose a pilot study consisting of a series of high signal-to-noise (SNR) observations of the nearby stellar binary alpha Cen A and B to make precise measurements of their relative orbit. In addition to probing the limits of ALMA's differential astrometric precision, these measurements will improve our knowledge of the orbit of the alpha Cen AB system by factors of two to five in just a few years and will form the start of a search for exoplanets in this system.

**APPROVED!**

<b>PI NAME:</b>	Rachel Akeson			<b>SCIENCE CATEGORY:</b>	Circumstellar disks, exoplanets and the solar system
<b>ESTIMATED 12M TIME:</b>	<b>18.0 h</b>	<b>ESTIMATED ACA TIME:</b>	<b>0.0 h</b>	<b>ESTIMATED NON-STANDARD MODE TIME (12-M):</b>	<b>18.0 h</b>
<b>CO-PI NAME(S): (Large &amp; VLBI Proposals only)</b>					
<b>CO-INVESTIGATOR NAME(S):</b>	Chas Beichman; Pierre Kervella; Ed Fomalont; George Benedict				

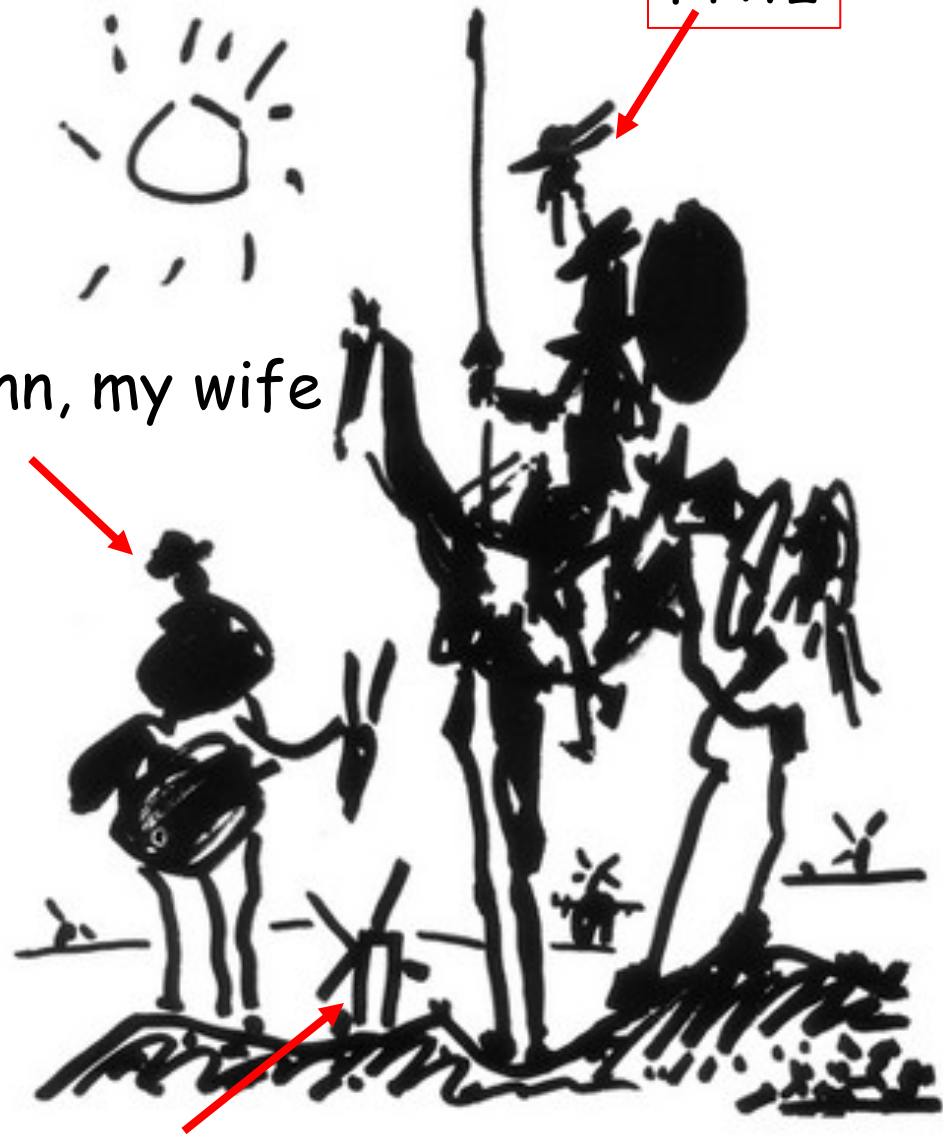

Fritz

Ann, my wife

$\alpha$  Cen

# 172 Years of Not Finding a Planet with Astrometry

## Summary

Astrometry has yet to independently discover an exoplanet

Astrometry has made useful contributions- exoplanet masses, system architecture, host star characterization

The future is seemingly bright, although true Earth analogs just out of reach (Like fusion power? Always a few years off in the future?)

# THE ASTRONOMICAL PYRAMID

ILLUSTRATING THE INTERDEPENDENCE OF THE VARIOUS AREAS OF STUDY

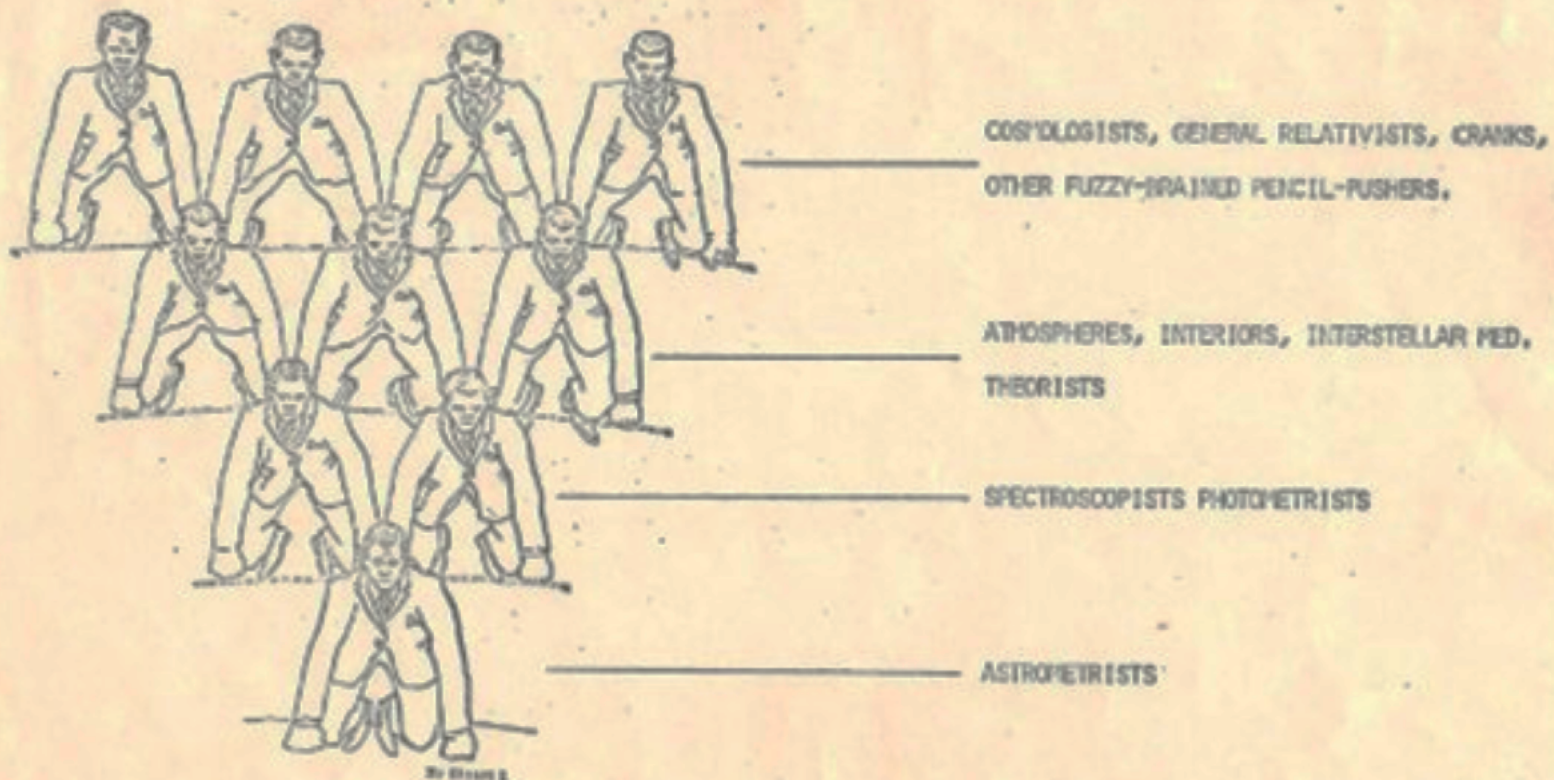

GET BACK TO BASICS -- SUPPORT ASTRONOMY



