

Exploring the interface between RV and transits



Josh Winn

Massachusetts Institute of Technology

PRIMER ratios
Doppler Rossiter
useful overall radius
usually Examples
therefore think companions
far
need
nontransiting
study
good
orbits
mass
times find
fitting Detect
offset TVs
Mass
Also
models
turns radii learn e/w
resolution relative ingredients
assume understand
orbit Show
even away
now
data p-modes
fact
period
time
know
inferrence
transit
gravitational
Measure
Recognize shift
calculate
in-plane
2/3
uncertainty
star
photometric
RVs
density
planets
velocity
eccentricity
masses
get
RV
parameters
measure
effect two
high Case
practice
transiting
mapping
Age principle
HARPS tell come
better etc rho
curve atmospheres
derive used
still may
sure toward
Kepler
phases
magnetic
beaming component
small
help factor
Teff eccentric bring
fraction gained
parallax photometry
circular
conjunction
spectrum also
also
may
surface
periods
better etc rho
curve atmospheres
derive used

- Measure planet masses
- Detect non-transiting companions
- Survey with different selection function
- Measure stellar obliquity (RM effect)

Measure planet masses

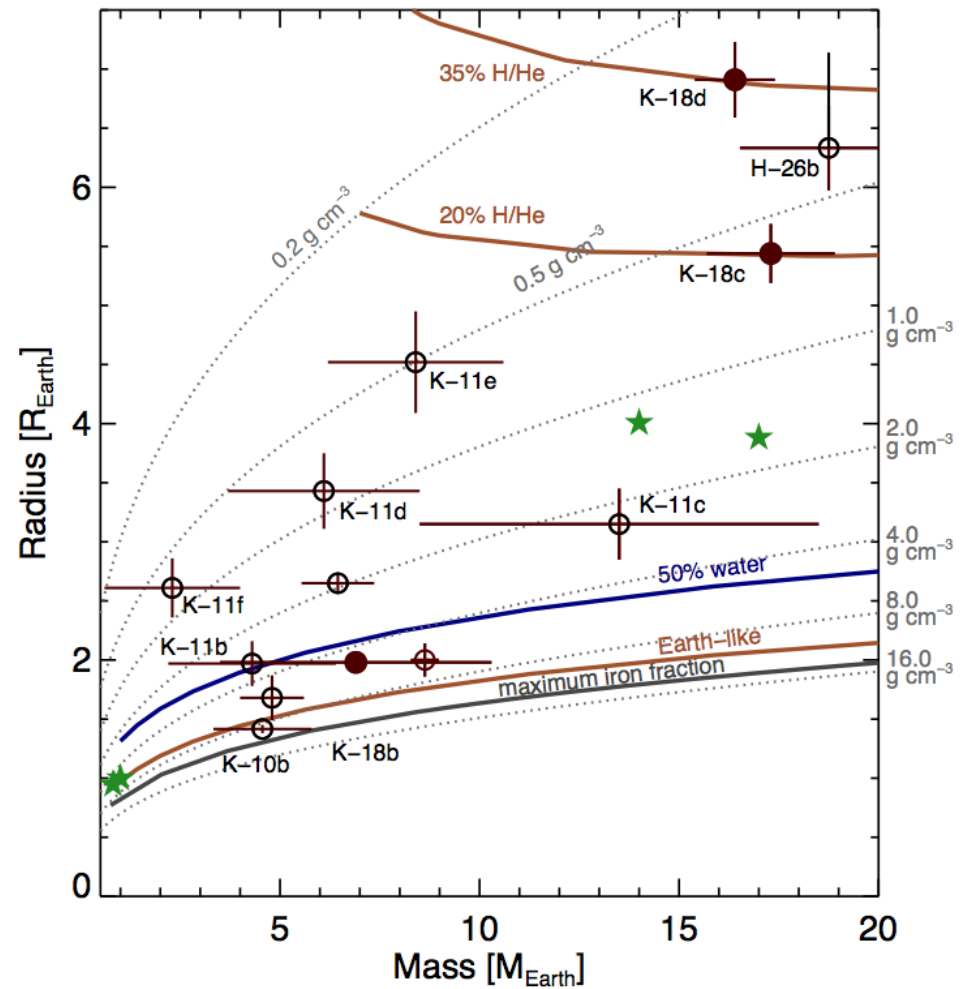
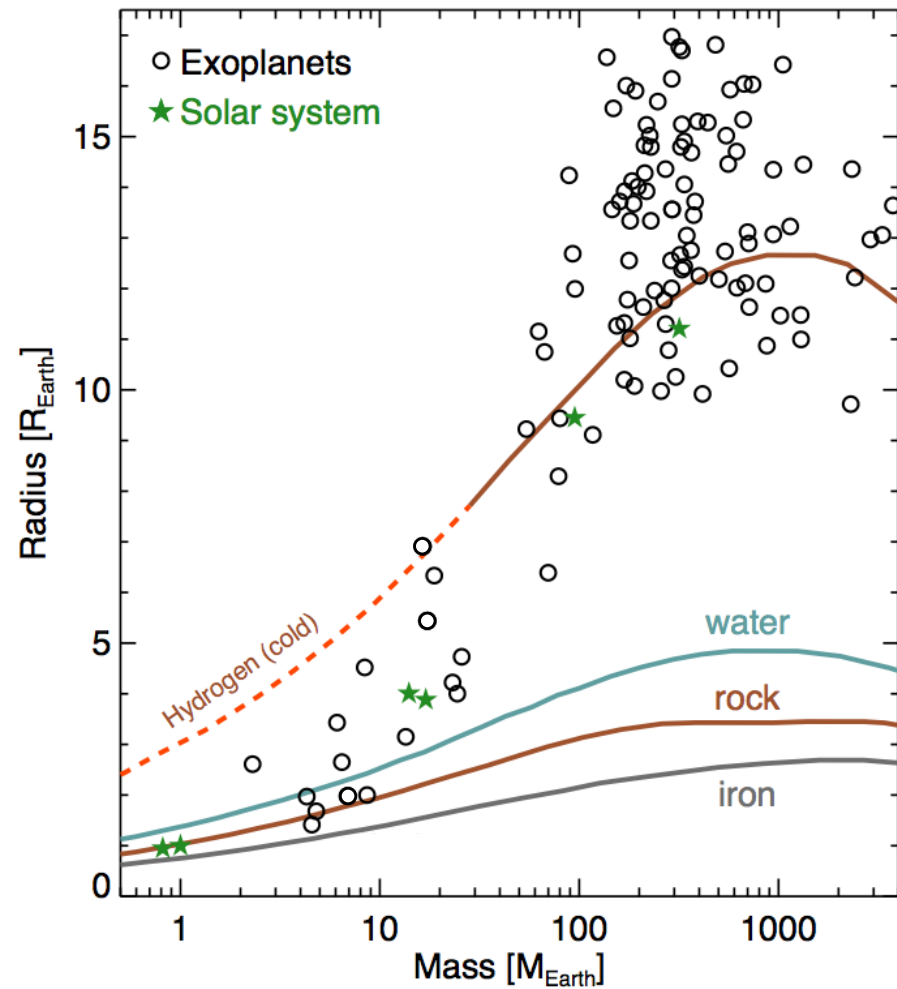

Circular orbit

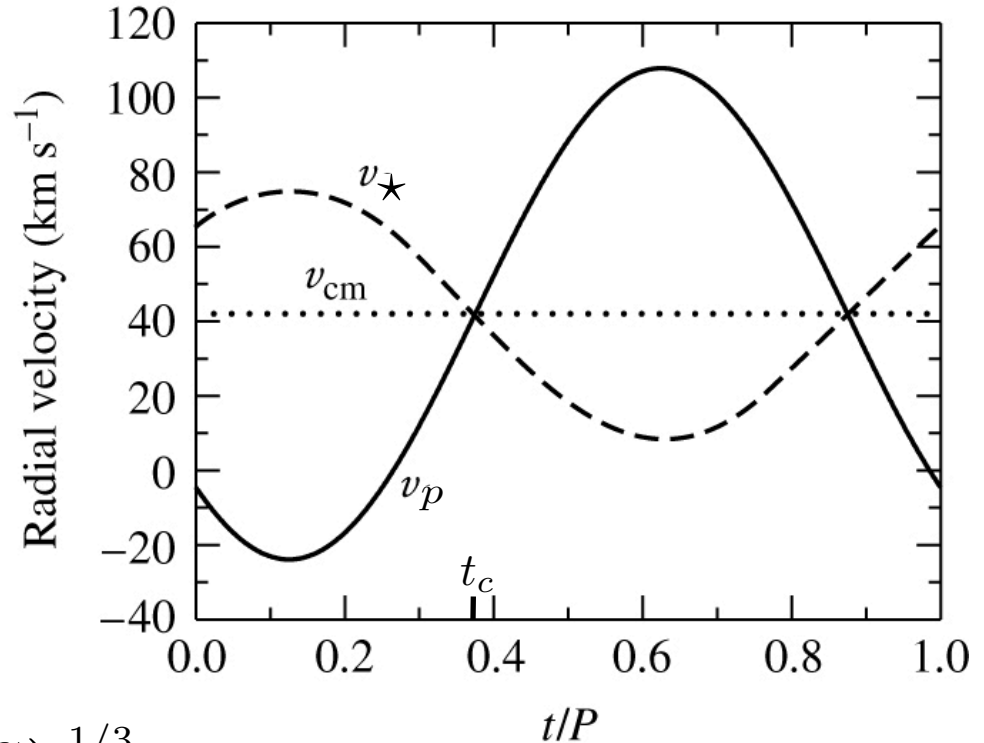
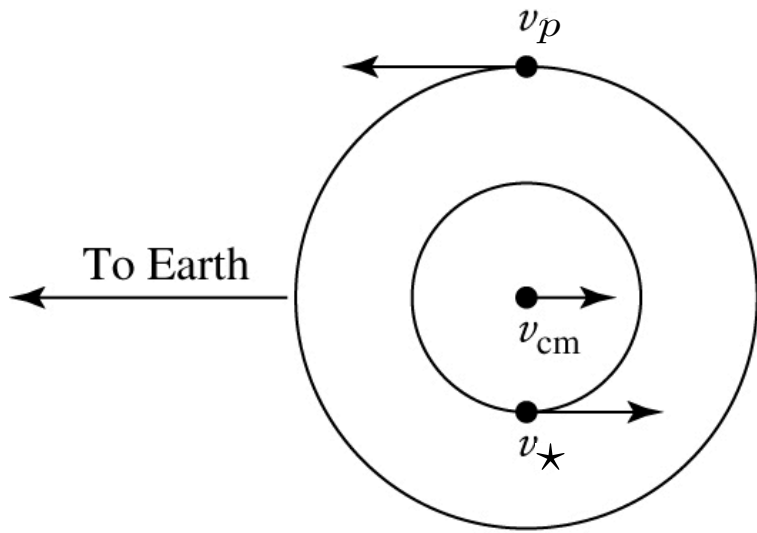

$$v_{\star} = \frac{2\pi a_{\star}}{P}$$

$$a_{\star} = \frac{m_p}{m_{\star} + m_p} a$$

$$\frac{G(m_{\star} + m_p)}{a^3} = \left(\frac{2\pi}{P}\right)^2$$

$$v_{\star} = \left(\frac{2\pi G}{P}\right)^{1/3} \frac{m_p}{(m_{\star} + m_p)^{2/3}}$$

$$RV_{\star}(t) = - \left(\frac{2\pi G}{P}\right)^{1/3} \frac{m_p \sin I}{(m_{\star} + m_p)^{2/3}} \sin \left[\frac{2\pi(t - t_c)}{P} \right]$$

4 parameters: Offset, Period, Phase, Amplitude

Eccentric orbit

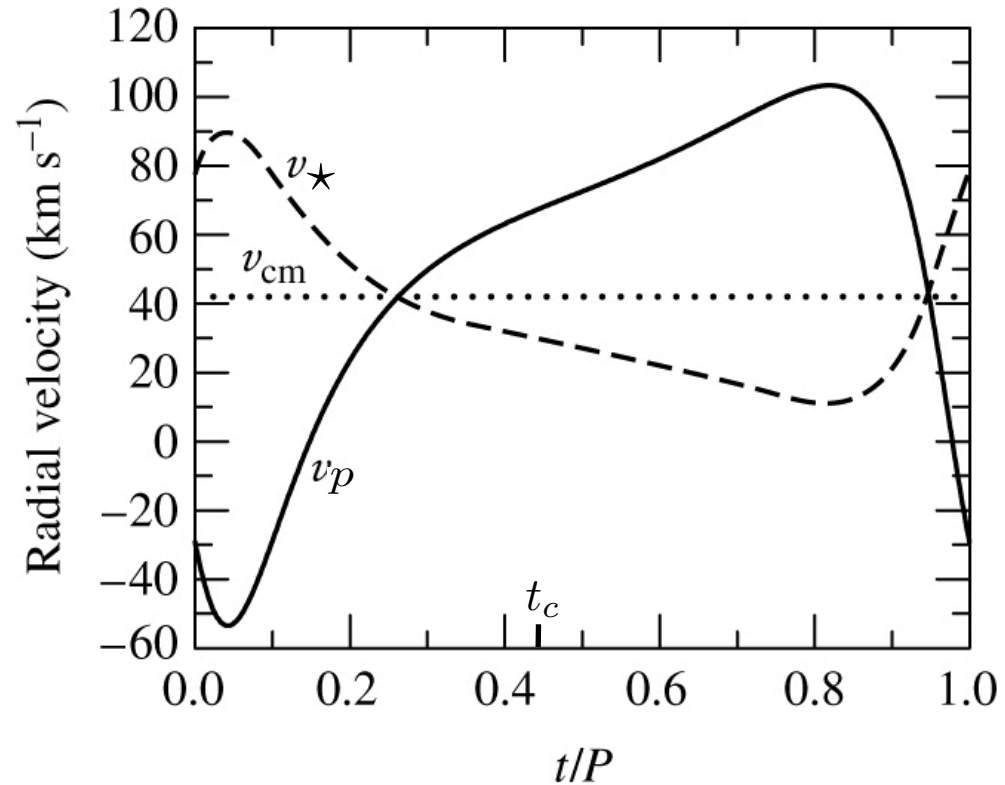
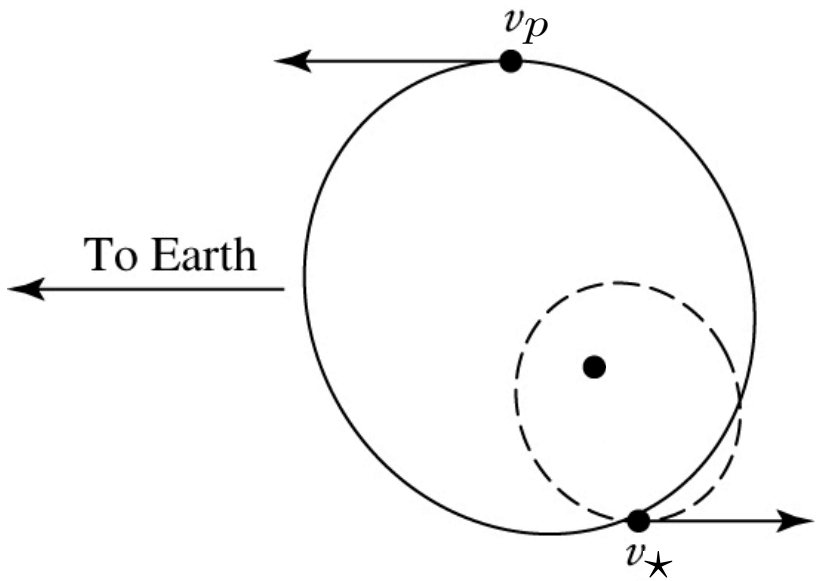

$$RV_{\star}(t) = \left(\frac{2\pi G}{P} \right)^{1/3} \frac{m_p \sin I}{(m_{\star} + m_p)^{2/3}} \frac{1}{\sqrt{1 - e^2}} \{ \cos [f(t) + \omega] + e \cos \omega \}$$

see, e.g., chap. 2 of *Exoplanets* (2010)

6 parameters: Offset, Period, Phase, Amplitude, e , ω

Radial velocity variations

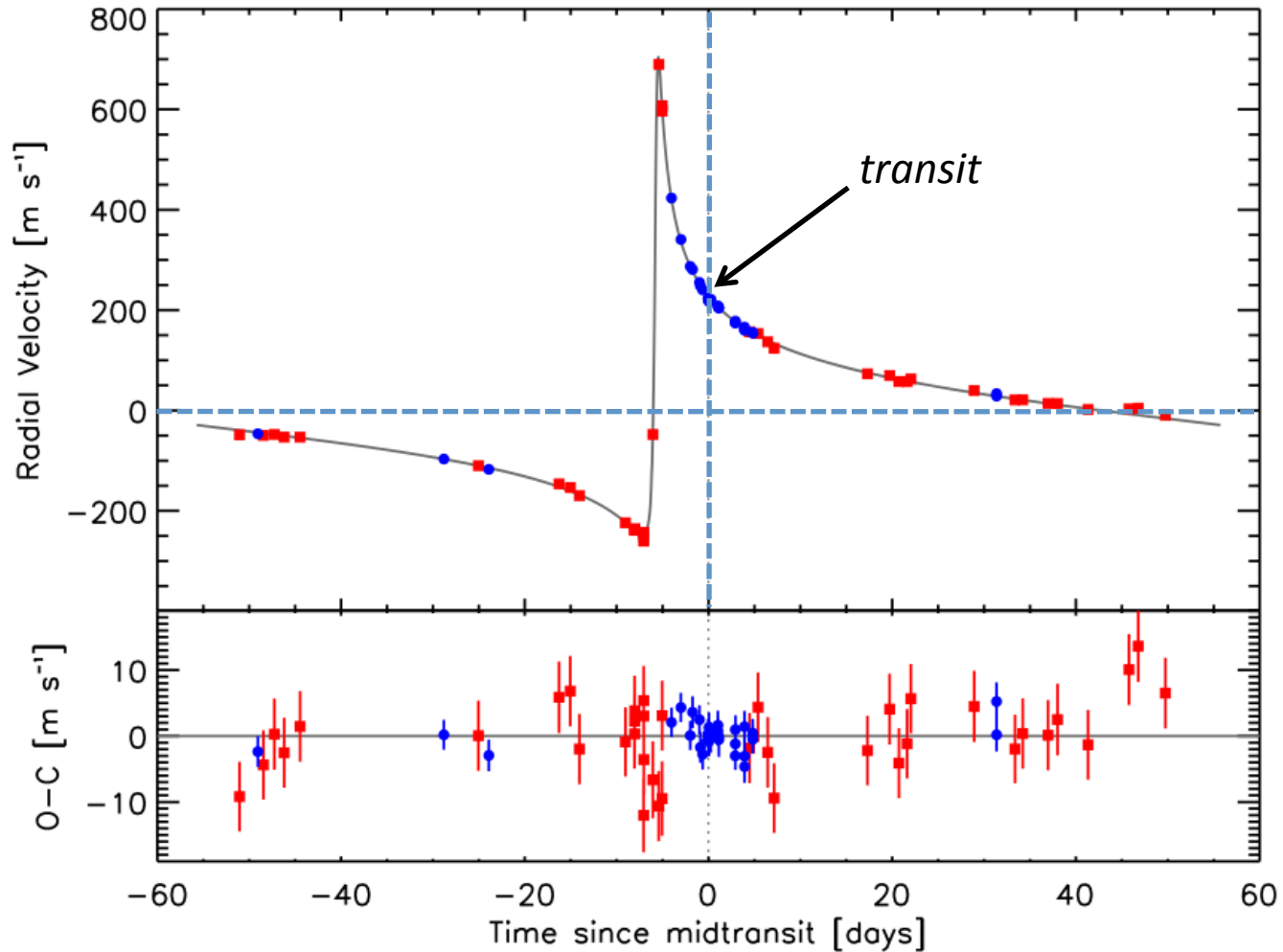
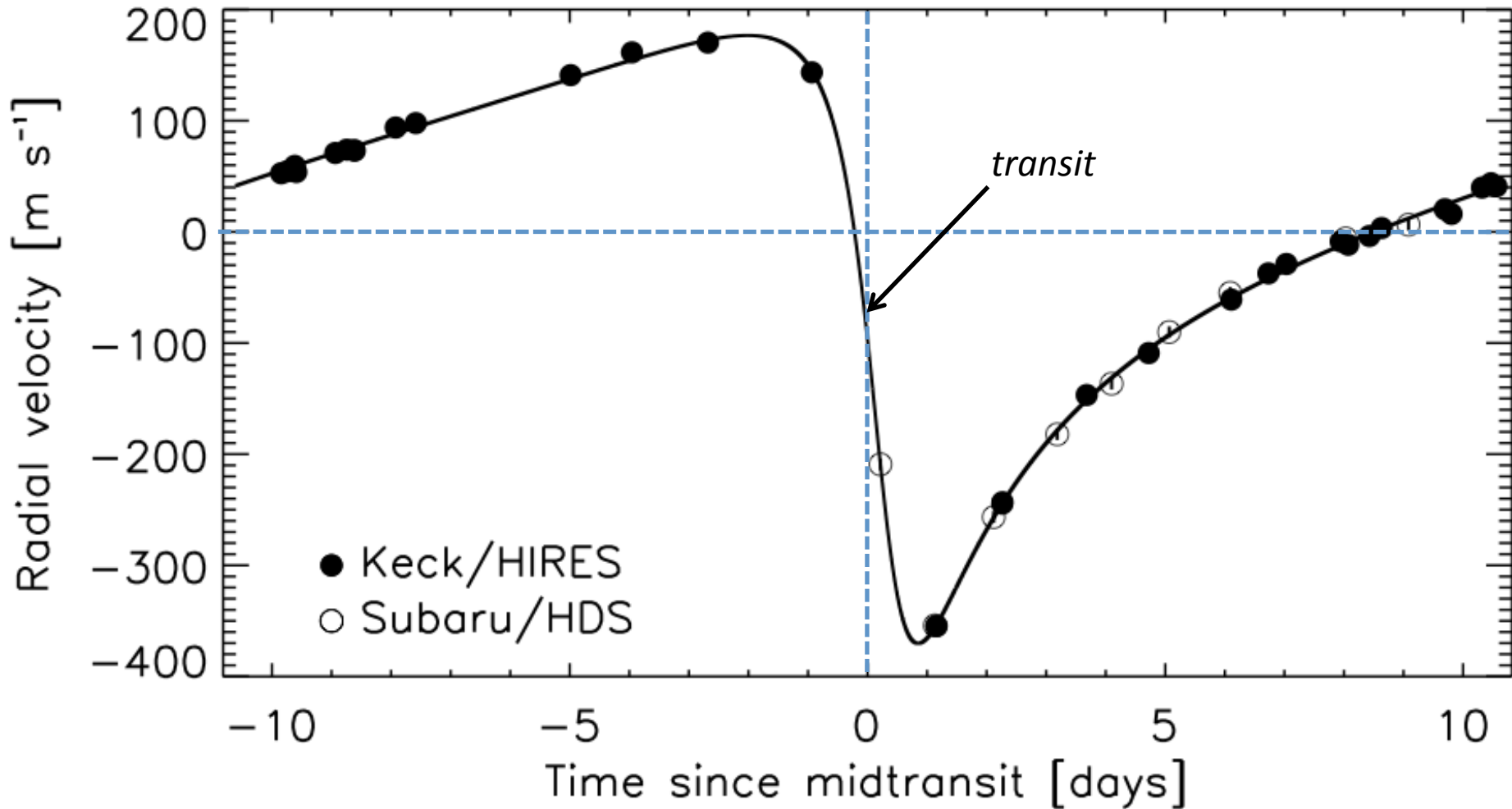
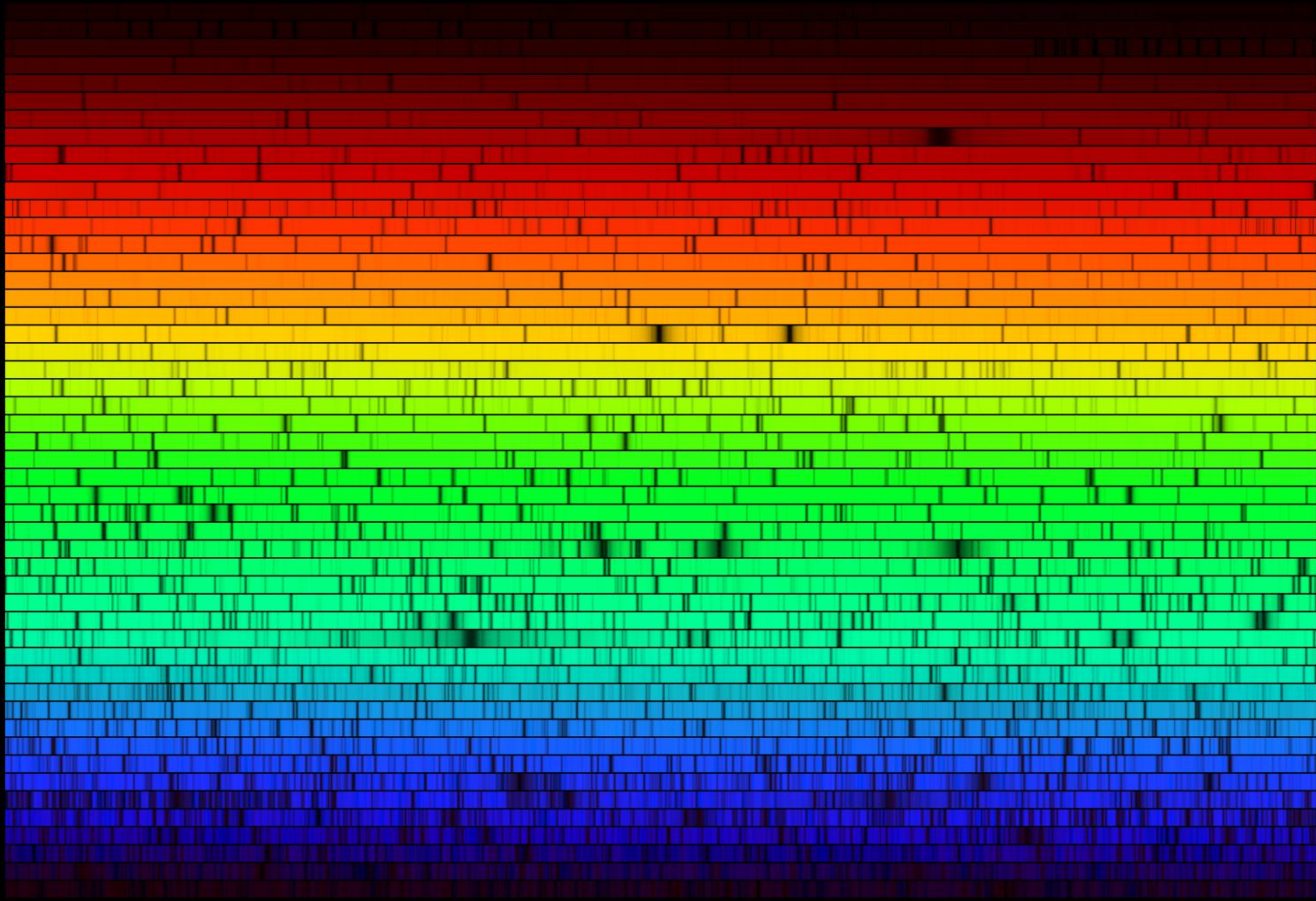

Figure 4. Radial-velocity variation of HD 80606, as a function of orbital phase.

Radial velocity variations





N.A.Sharp, NOAO/NSO/Kitt Peak FTS/AURA/NSF

Orders of magnitude

$$\frac{\Delta\lambda}{\lambda} = \frac{K_{\star}}{c}$$

$$K_{\star} \approx 140 \text{ m s}^{-1} \left(\frac{m_p \sin I}{M_{\text{Jup}}} \right) \left(\frac{m_{\star}}{M_{\odot}} \right)^{-2/3} \left(\frac{P}{3 \text{ days}} \right)^{-1/3}$$

$$K_{\star} \approx 9 \text{ cm s}^{-1} \left(\frac{m_p \sin I}{M_{\oplus}} \right) \left(\frac{m_{\star}}{M_{\odot}} \right)^{-2/3} \left(\frac{P}{1 \text{ year}} \right)^{-1/3}$$

$$R = \frac{\lambda}{\Delta\lambda} \sim 2 \times 10^6 \text{ to } 3 \times 10^9$$

Gas absorption cell

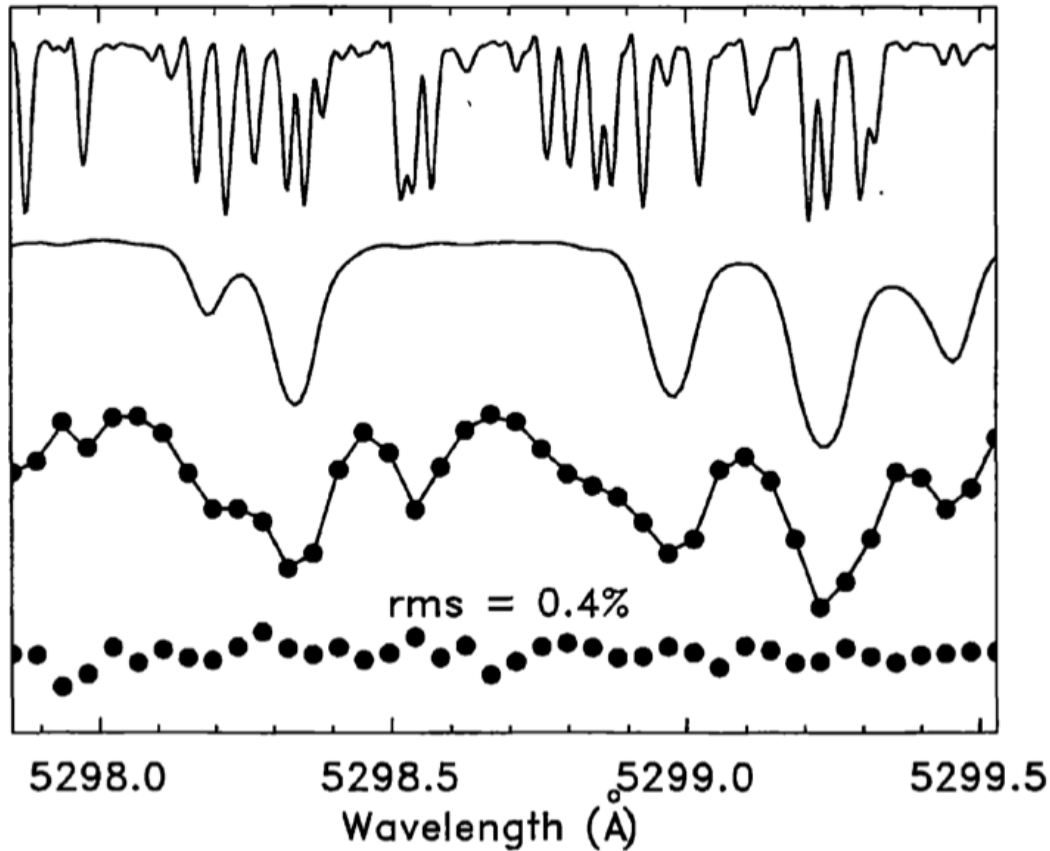

Examples:
Keck/HIRES
Magellan/PFS

FIG. 1—The modeling process. Top: The template iodine cell spectrum. Second: The template stellar spectrum (τ Ceti, G8 V). Third: The points are an observation of τ Ceti made through the iodine absorption. The solid line is a model of the observation. The model is composed of the template iodine and stellar spectra. The free parameters consist of the spectrograph PSF and the Doppler shift of the template star relative to the template iodine.

Butler et al. (1996)

Simultaneous reference

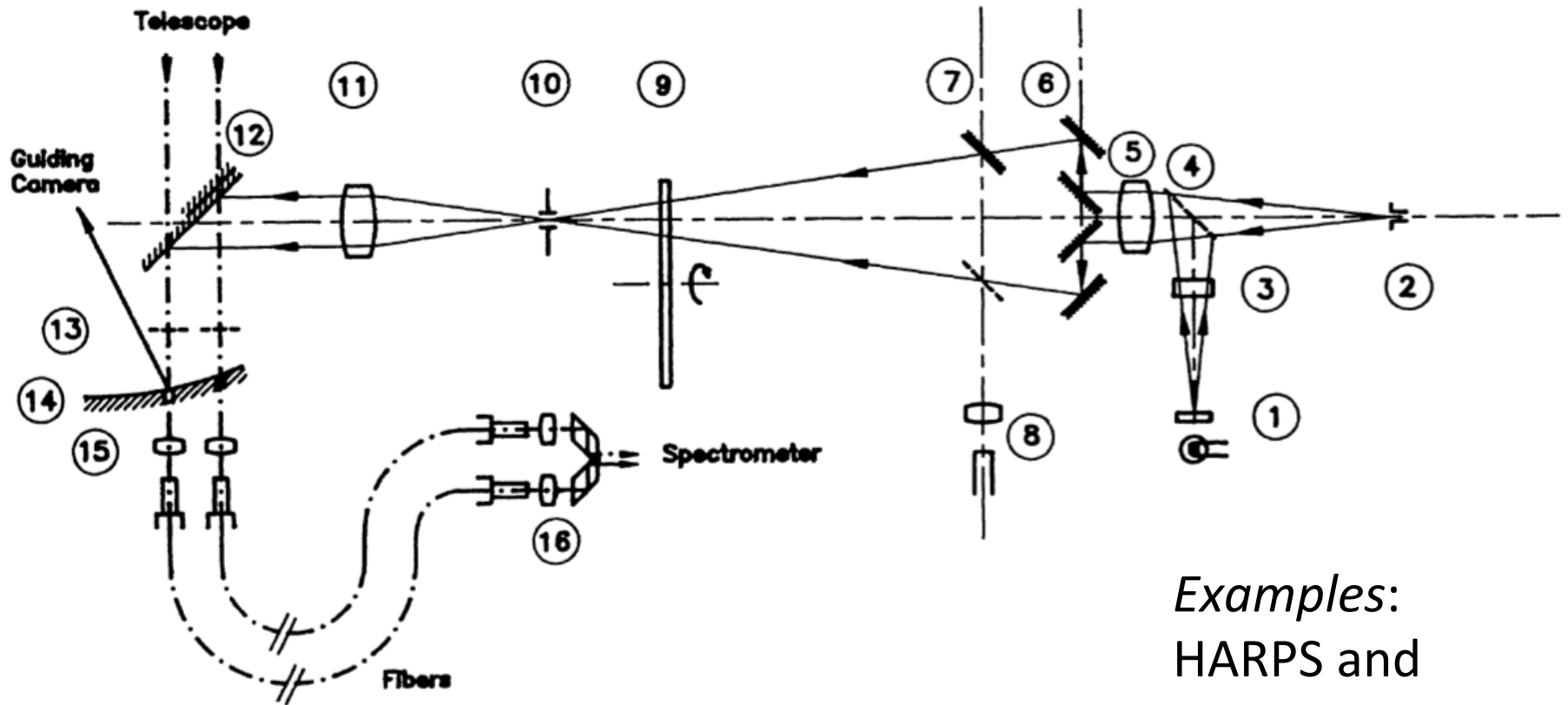

Examples:
HARPS and
HARPS-N

Fig. 4. Optical layout of the calibration system in the front end adaptor: 1) tungsten lamp and diffuser, 2) hollow cathode thorium lamp, 3) colour corrector filter. 4) static beam-splitter, 5) relay achromat, 6) mirrors for beam angular splitting, 7) removal mirror and beam splitting (part of the accelerometry experiment), 8) optical fibre of the Fabry-Perot light (part of the accelerometry experiment), 9) circular wedge 10) pupil, 11) achromat (to put the pupil at infinity), 12) calibration mirror, 13) fibre mask, 14) concave mirror with 2 holes, 15) spectrometer linking fibres and aperture converter, 16) aperture converter optics and rhomboid prisms (to bring the beams closer to the focus of the collimator)

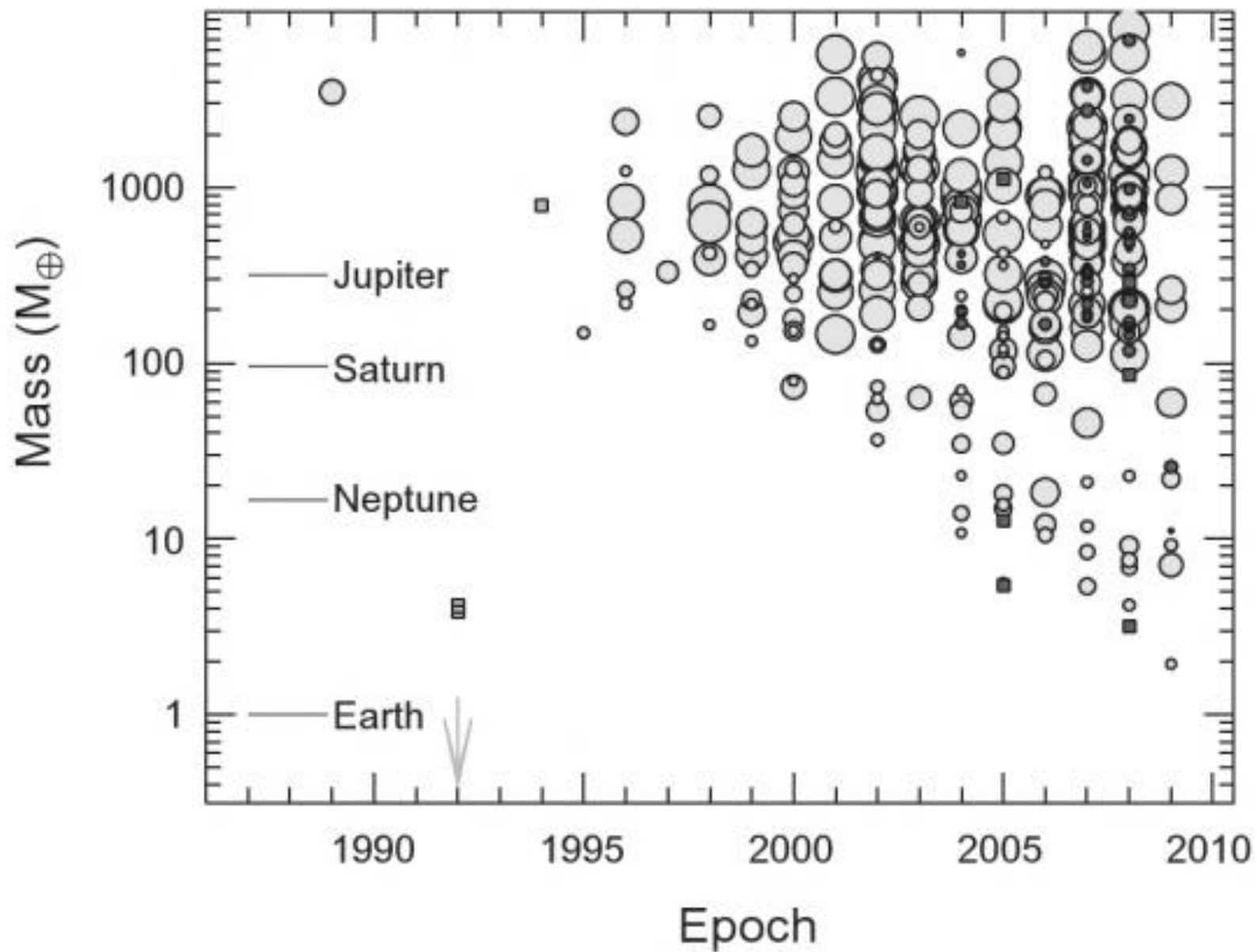

Stellar radial-velocity noise

Acoustic oscillations	minutes
Granulation	hours
Spots and plages	days
Long-term magnetic cycles	years

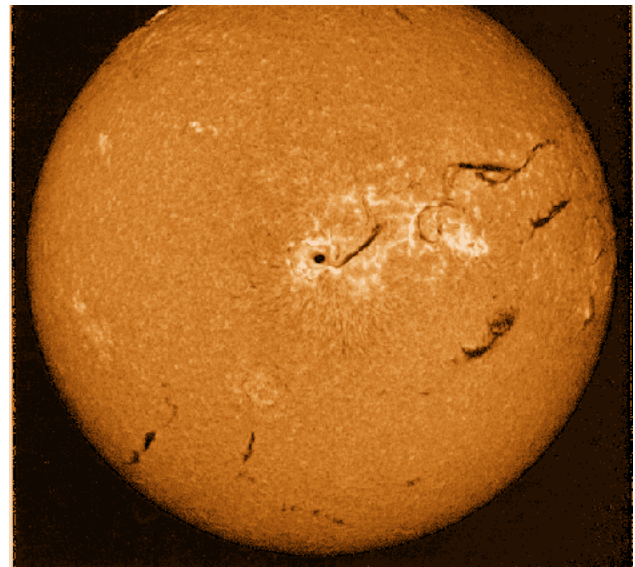
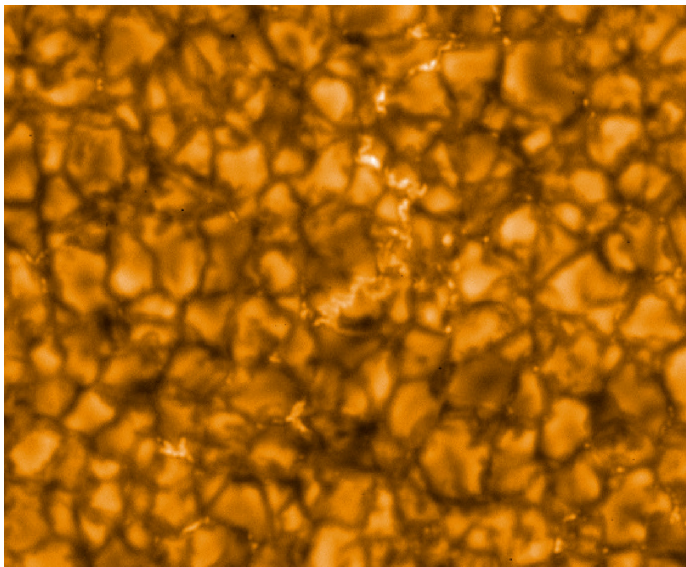
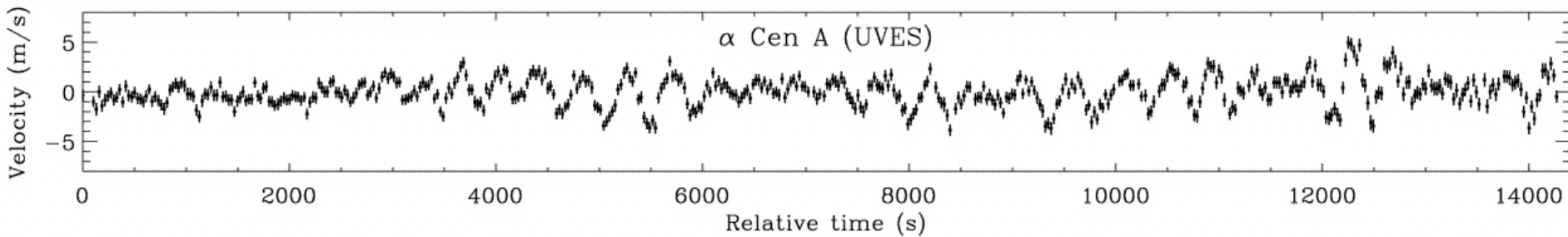

Transits help RV analysis

$$p_{\text{tra}} = \frac{R_{\star}}{a}$$

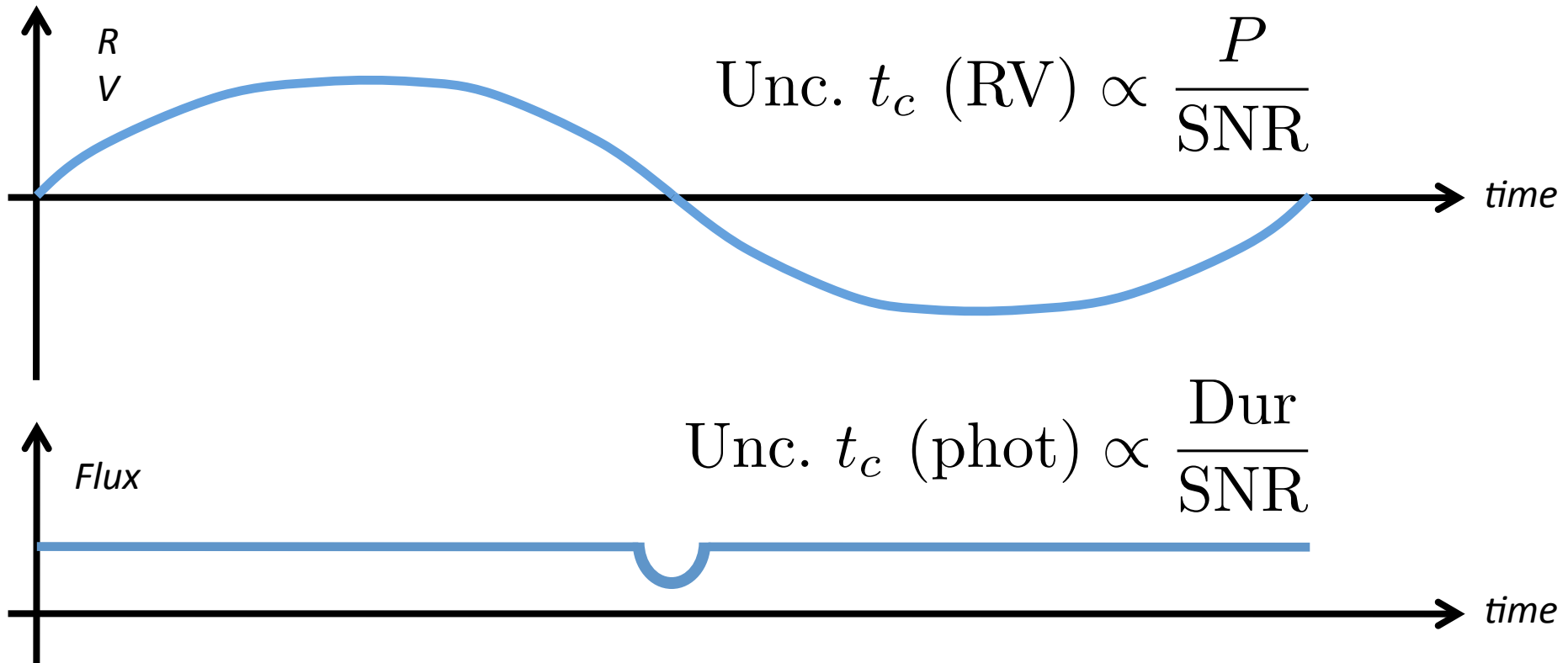

- 6 parameters: Offset, Period, Phase, Amplitude, e , ω
 - 4 parameters: Offset, Period, Phase, Amplitude, e , ω
 - 2 parameters: Offset, Period, Phase, Amplitude, e , ω
- with transits
- circular orbit

Eccentricity

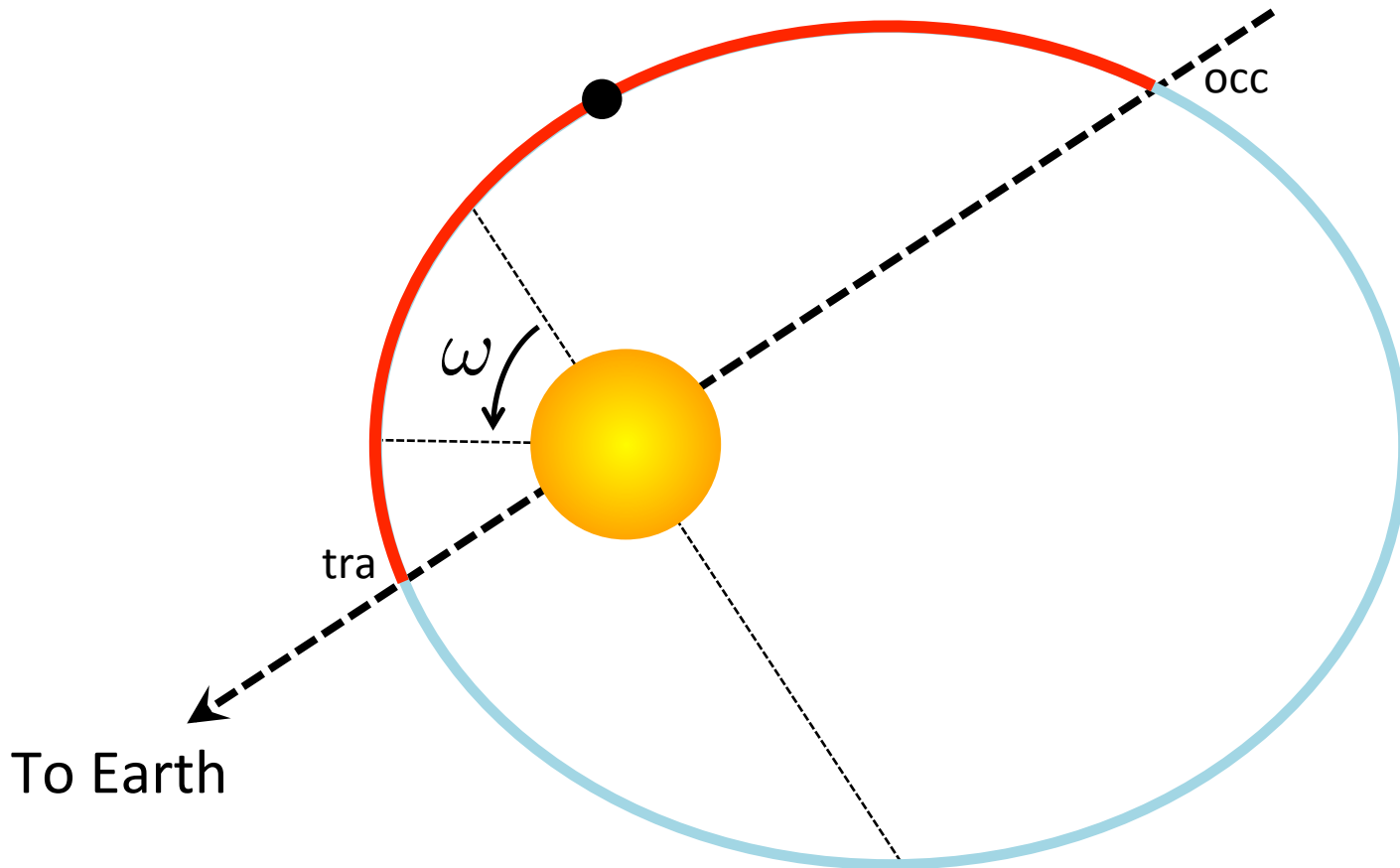

$$\Delta t_c \approx \frac{P}{2} \left[1 + \frac{4}{\pi} e \cos \omega \right]$$

$$\frac{T_{\text{occ}}}{T_{\text{tra}}} \approx \frac{1 + e \sin \omega}{1 - e \sin \omega}$$

Stellar mean density

Light curves: time, time⁻¹, dimensionless

$$G = 6.673 \times 10^{-11} \text{ kg}^{-1} \text{ m}^3 \text{ s}^{-2}$$

$$\frac{1}{G} = 1.16 \text{ (g cm}^{-3}\text{) hr}^2 \quad \leftarrow \text{ We expect to learn something with units g cm}^{-3}$$

$$\rho_{\star} + \delta^{3/2} \rho_p = \frac{3\pi}{GP^2} \left(\frac{a}{R_{\star}} \right)^3$$

$$\frac{a}{R_{\star}} \approx \frac{\delta^{1/4}}{\pi} \frac{P}{\sqrt{T\tau}} \frac{\sqrt{1-e^2}}{1+e\sin\omega}$$

Transit light curves + (e, ω) + Kepler's 3rd law \rightarrow
Stellar mean density

Planetary surface gravity

Light curves: time, time⁻¹, dimensionless

$c = 2.9979 \times 10^{10} \text{ cm s}^{-1}$ ← We expect to learn something with units cm, cm s⁻²

$$g_p \equiv \frac{GM_p}{R_p^2} = \frac{2\pi}{P} \frac{\sqrt{1-e^2} K_*}{(R_p/a)^2 \sin i} \quad \text{Southworth et al. (2007)}$$

Transit light curves + (e, ω) + K_* + Kepler's 3rd law →
Planetary surface gravity



YOUR WEIGHT ON OTHER WORLDS

Ever wonder what you might weigh on Mars or The Moon? Here's your chance to find out.

The Planets

MERCURY



Your weight is

VENUS

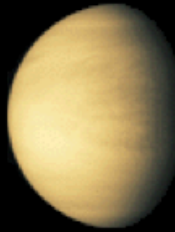

Your weight is

THE MOON



Your weight is

MARS

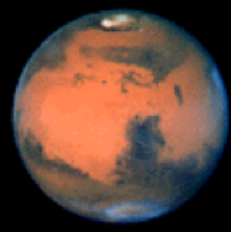

Your weight is

JUPITER

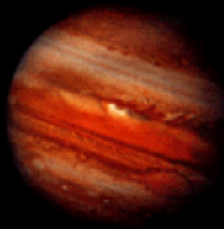

Your weight is

SATURN



Your weight is

URANUS

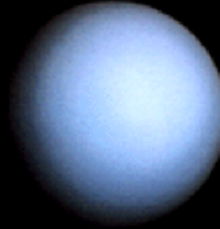

Your weight is

NEPTUNE

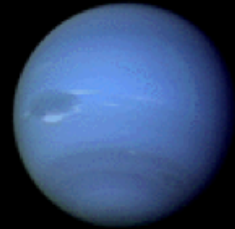

Your weight is

Case study: TrES-4

Mandushev et al. (2007)

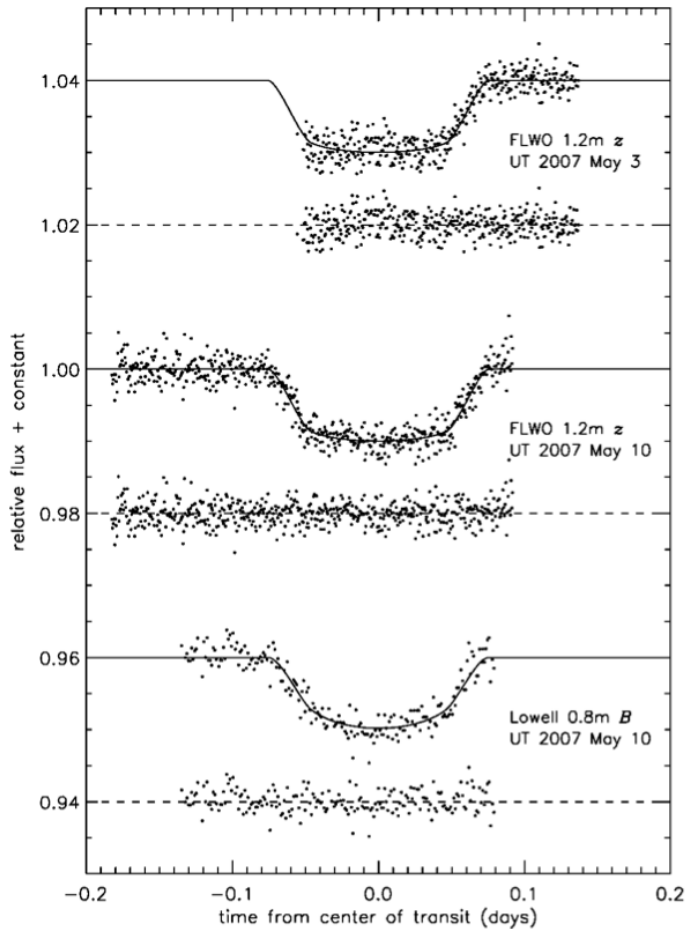

$$\begin{array}{c}
 P, t_c \\
 R_p/R_* \\
 b, \text{Duration} \xrightarrow{\text{assume } e=0} \rho_*
 \end{array}$$

Optical spectrum

Stellar atmosphere models

T_{eff}, Z

Stellar evolution models

M_*, R_*

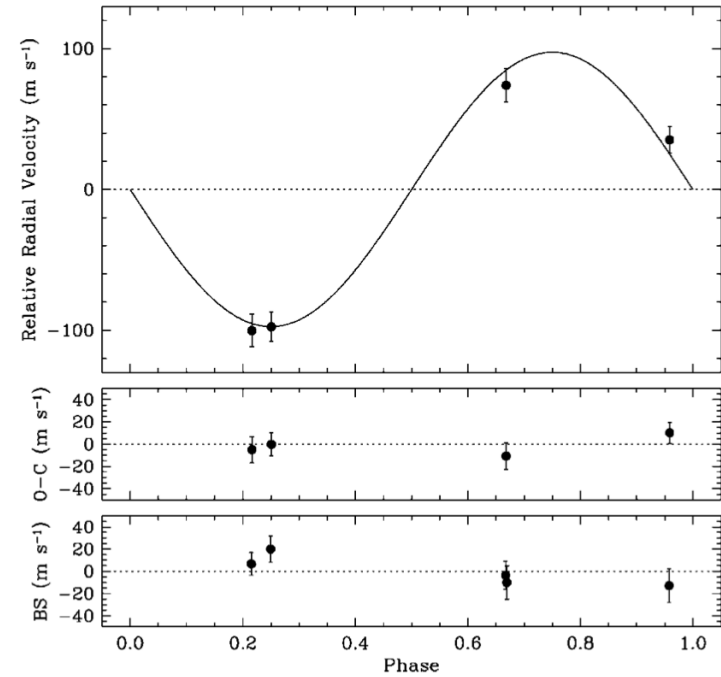

Case study: TrES-4

Mandushev et al. (2007)

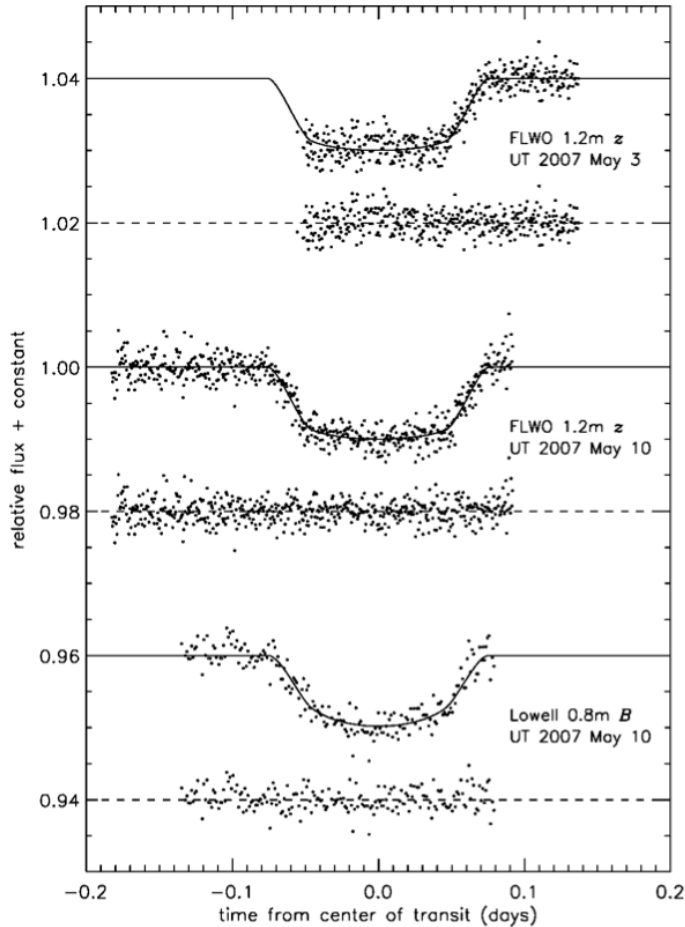

P, t_c
 R_p/R_*
 $b, \text{Duration}$

Optical spectrum

Stellar atmosphere models

T_{eff}, Z

M_*, R_*

assume $e = 0$

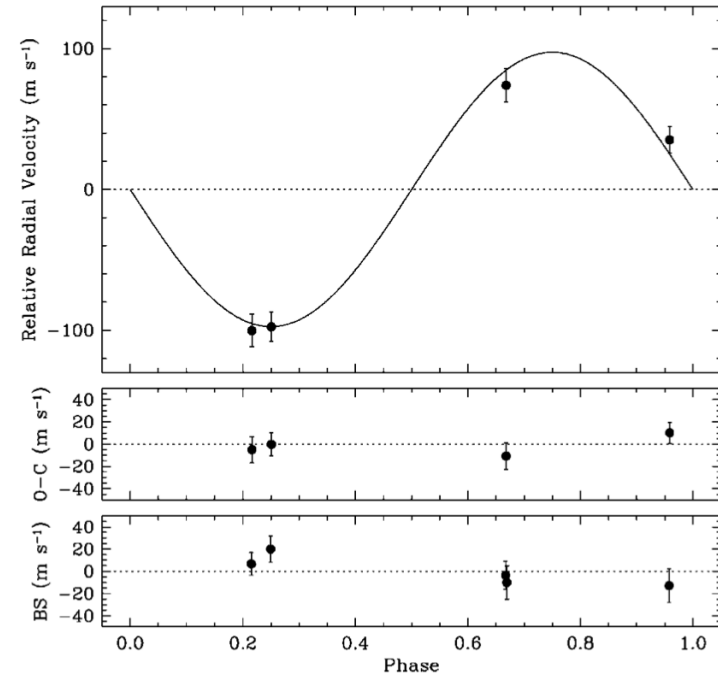

K_*

Case study: TrES-4

Mandushev et al. (2007)

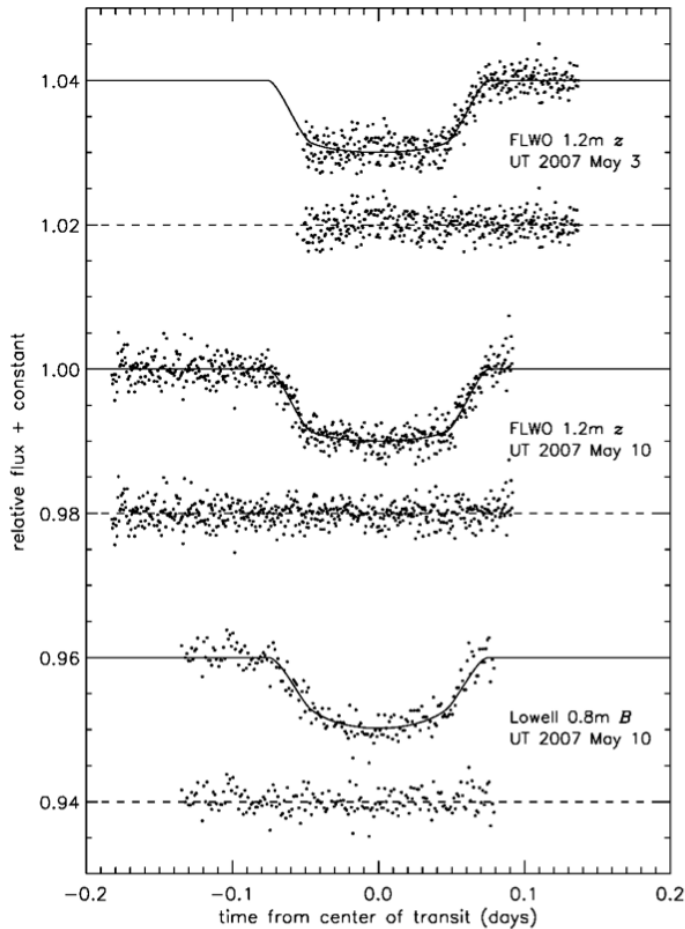

Optical spectrum

Stellar atmosphere models

T_{eff}, Z

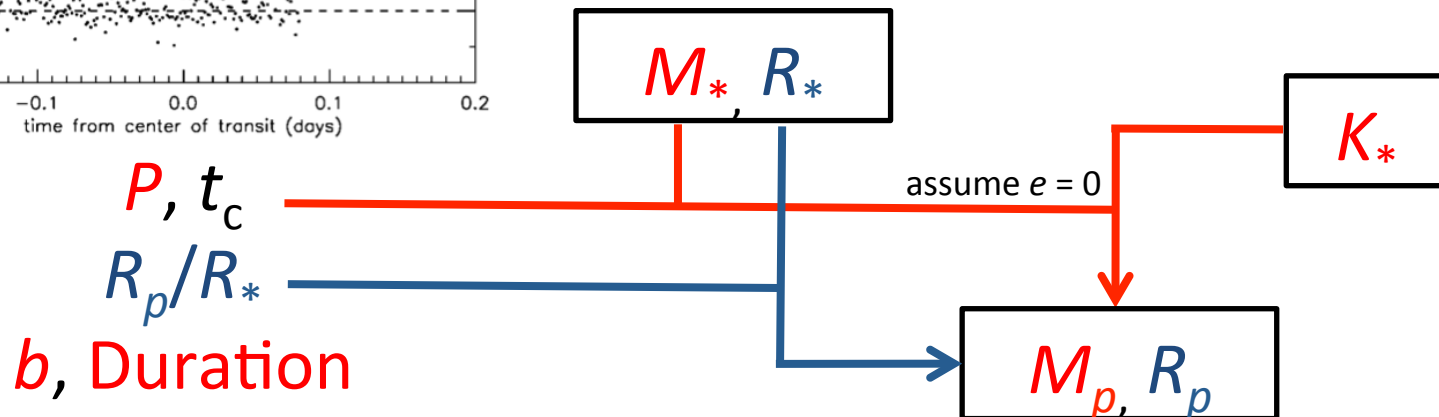
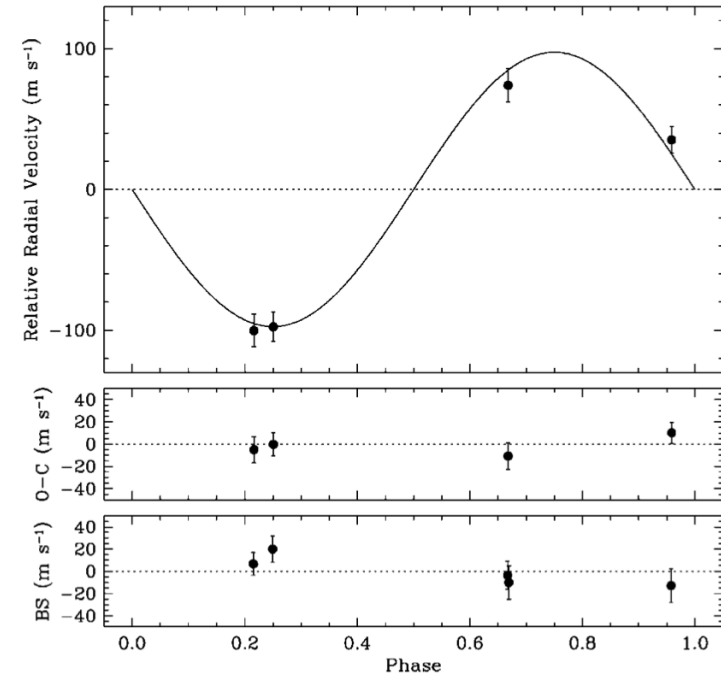

Case study: HAT-P-34

Bakos et al. (2012)

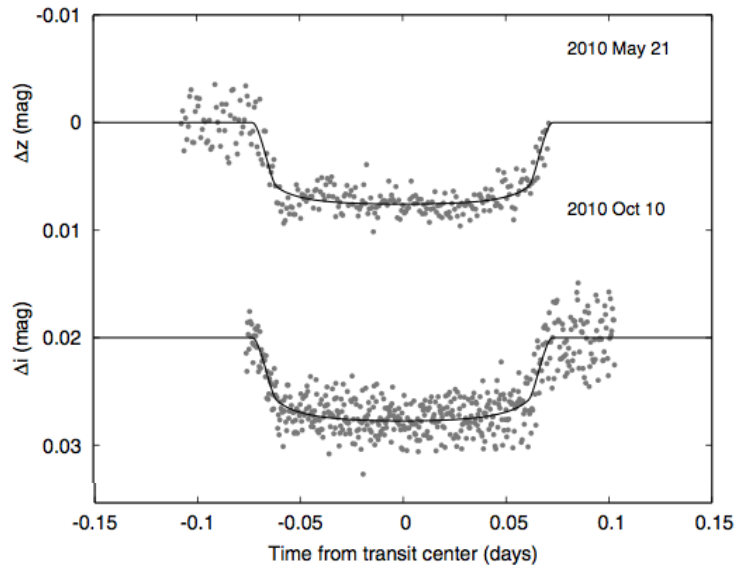

Optical spectrum

Stellar atmosphere models

T_{eff}, Z

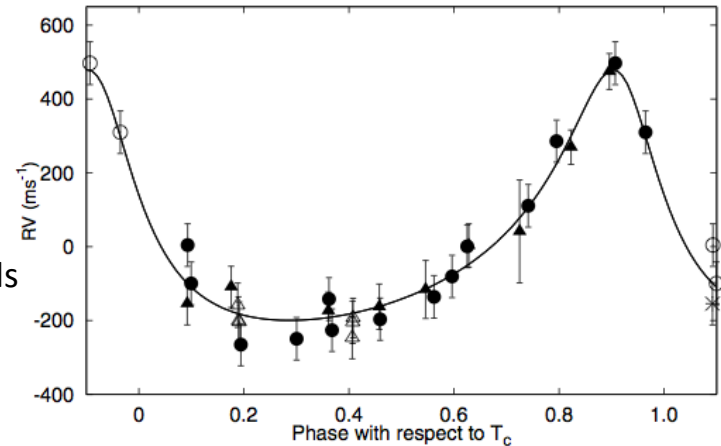

P, t_c
 R_p/R_*
 $b, \text{Duration}$

K_*, e, ω

Case study: HAT-P-34

Bakos et al. (2012)

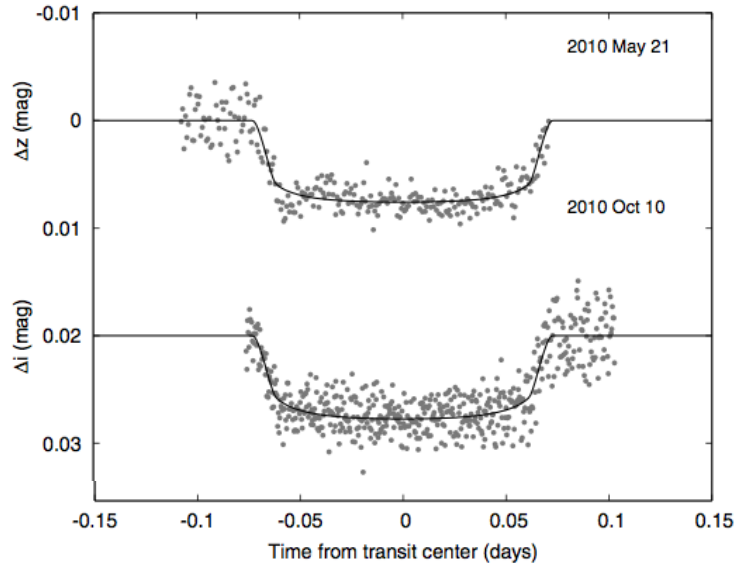

Optical spectrum

Stellar atmosphere models

T_{eff}, Z

Stellar evolution models

M_*, R_*

K_*, e, ω

ρ_*

P, t_c
 R_p/R_*
 $b, \text{Duration}$

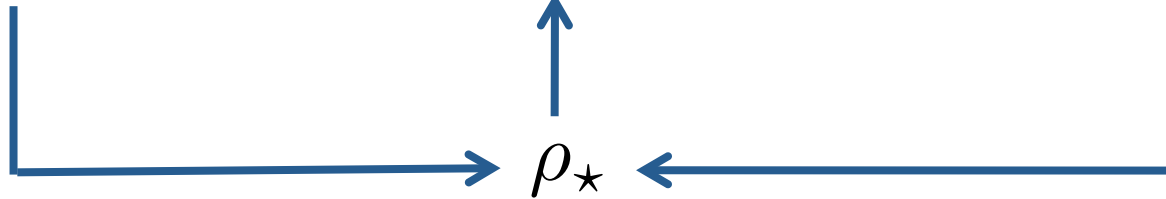
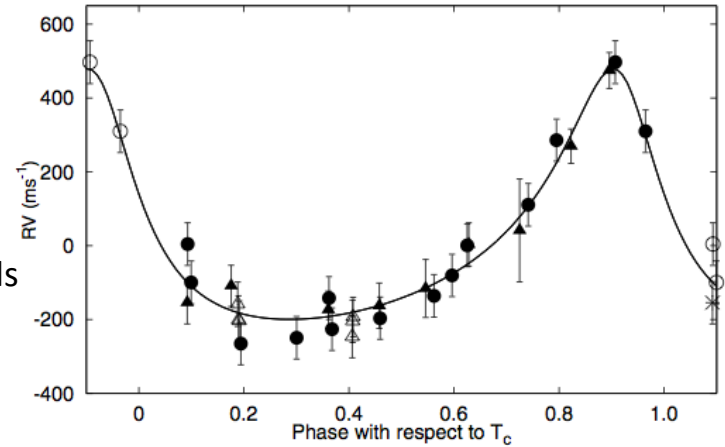

Case study: HAT-P-34

Bakos et al. (2012)

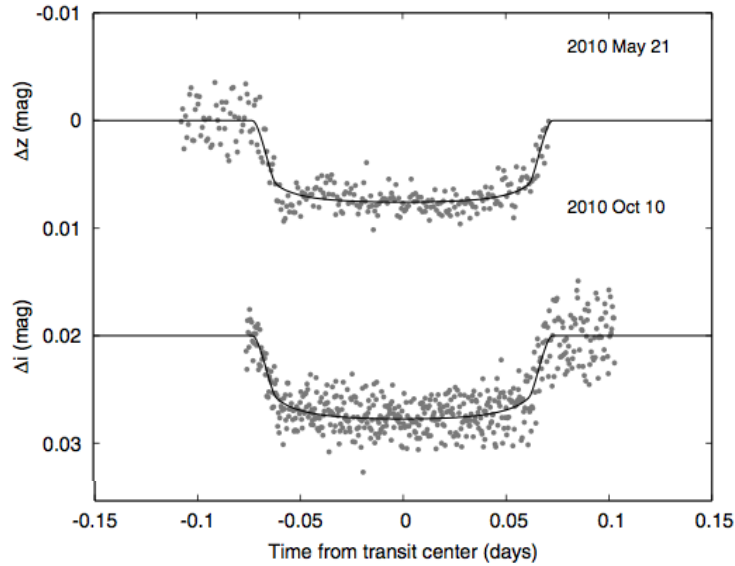

Optical spectrum

Stellar atmosphere models

T_{eff}, Z

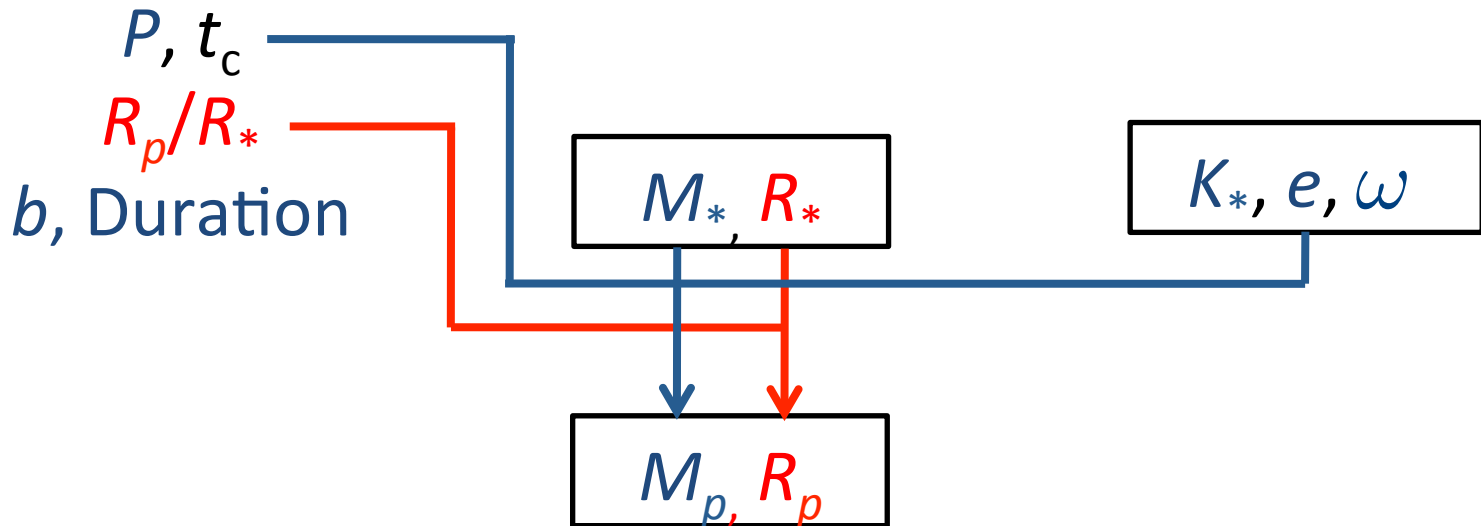
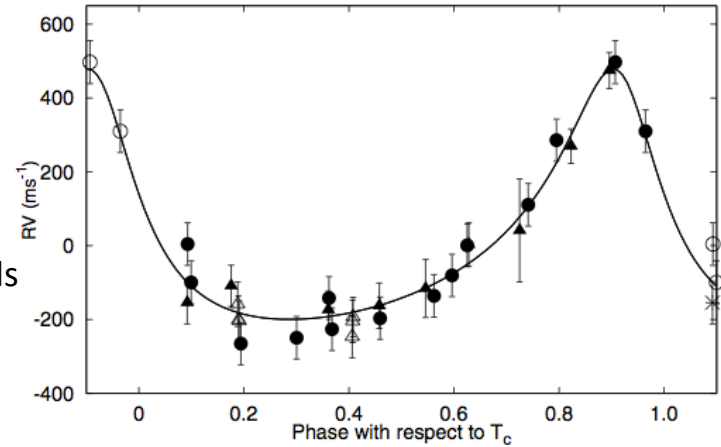

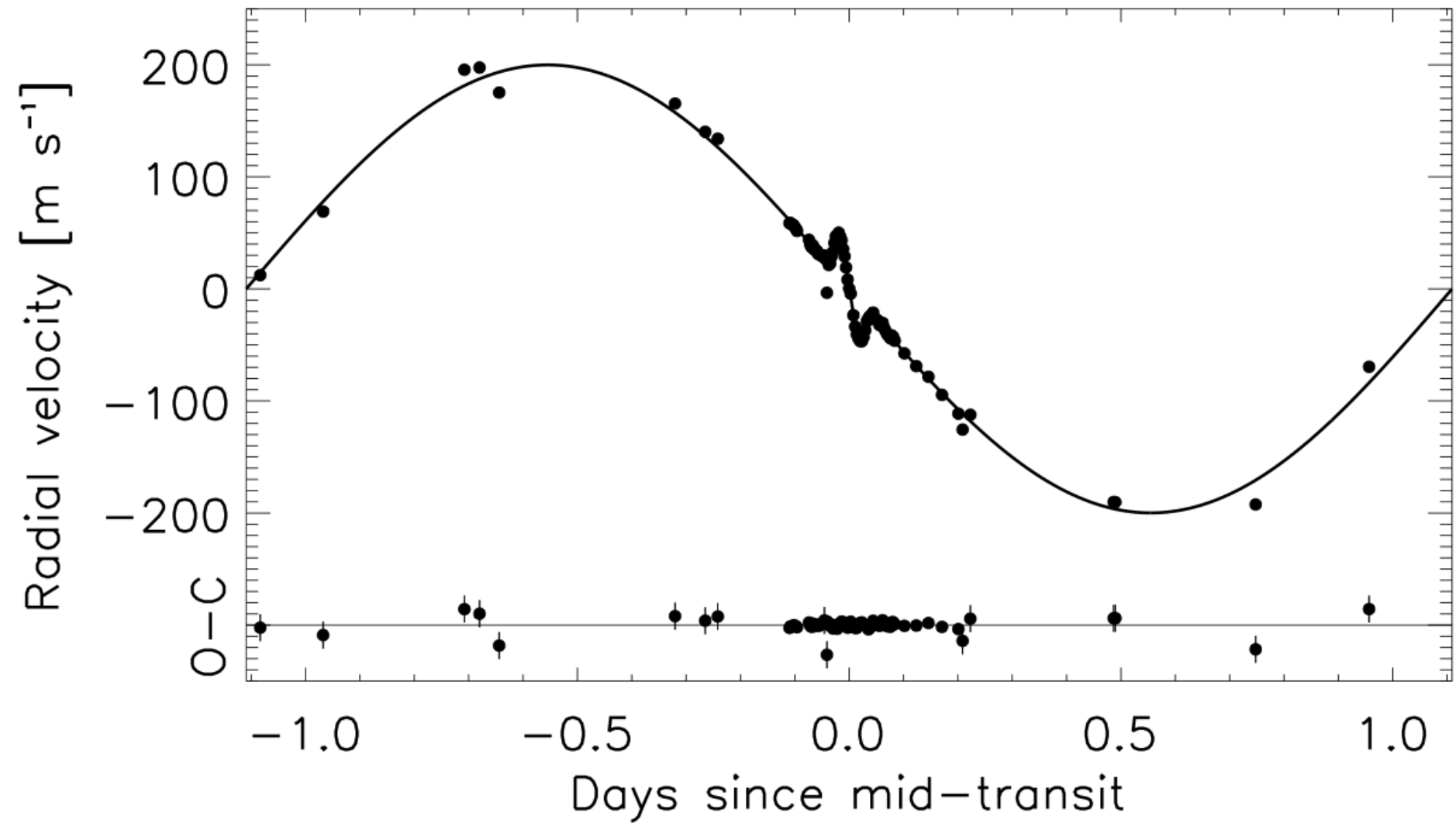

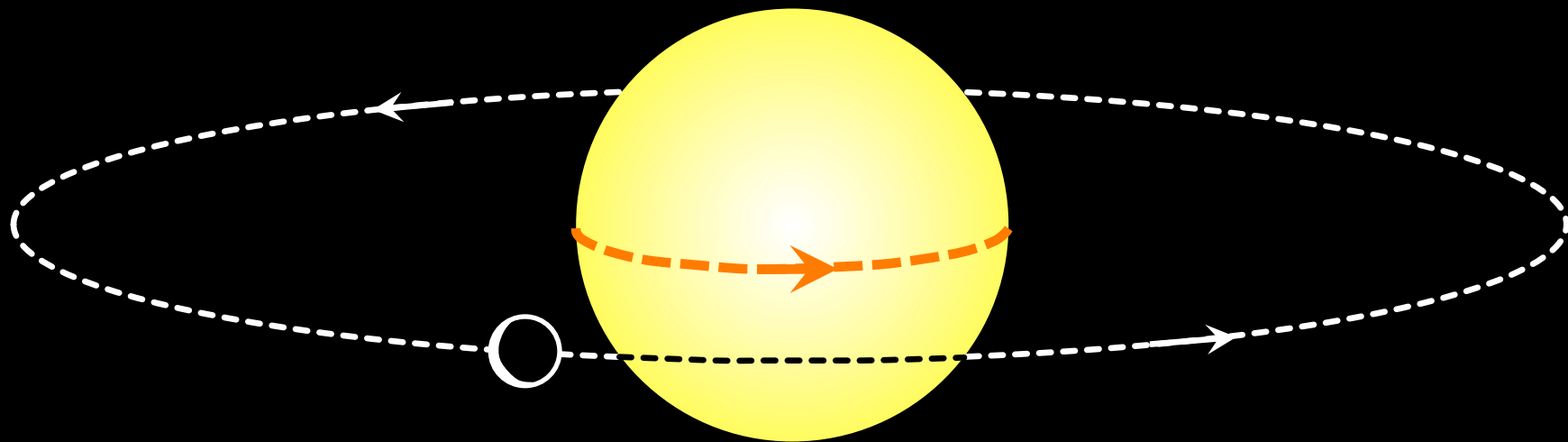

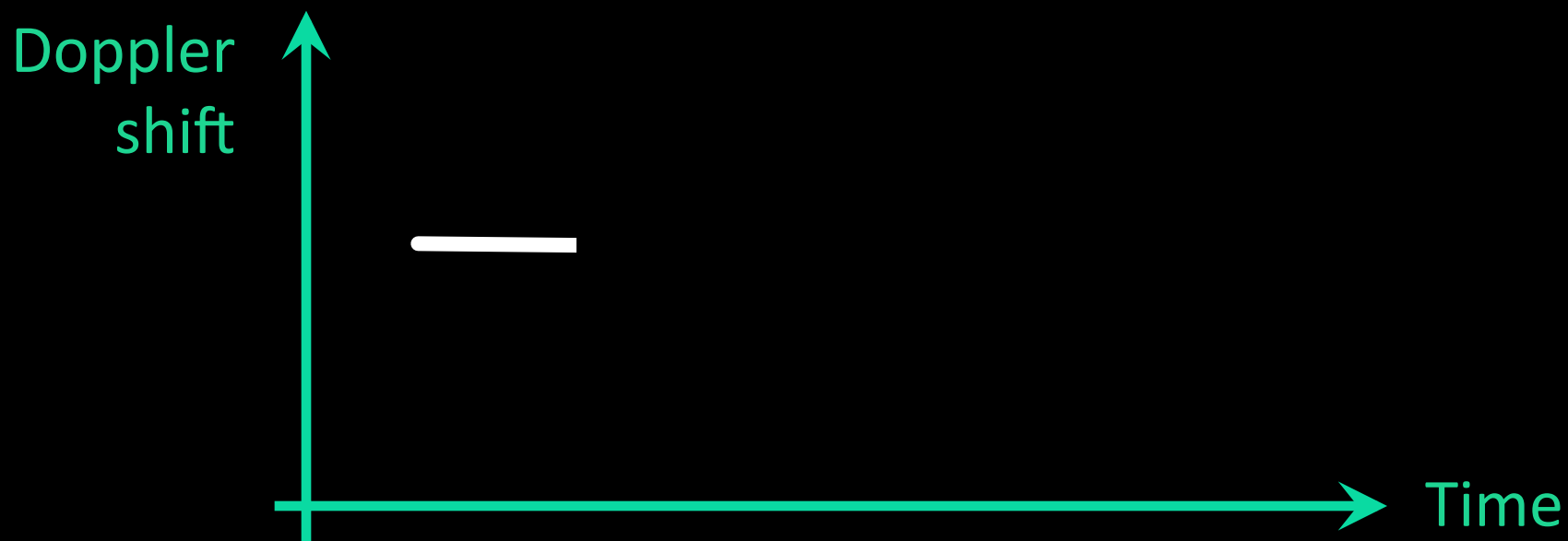
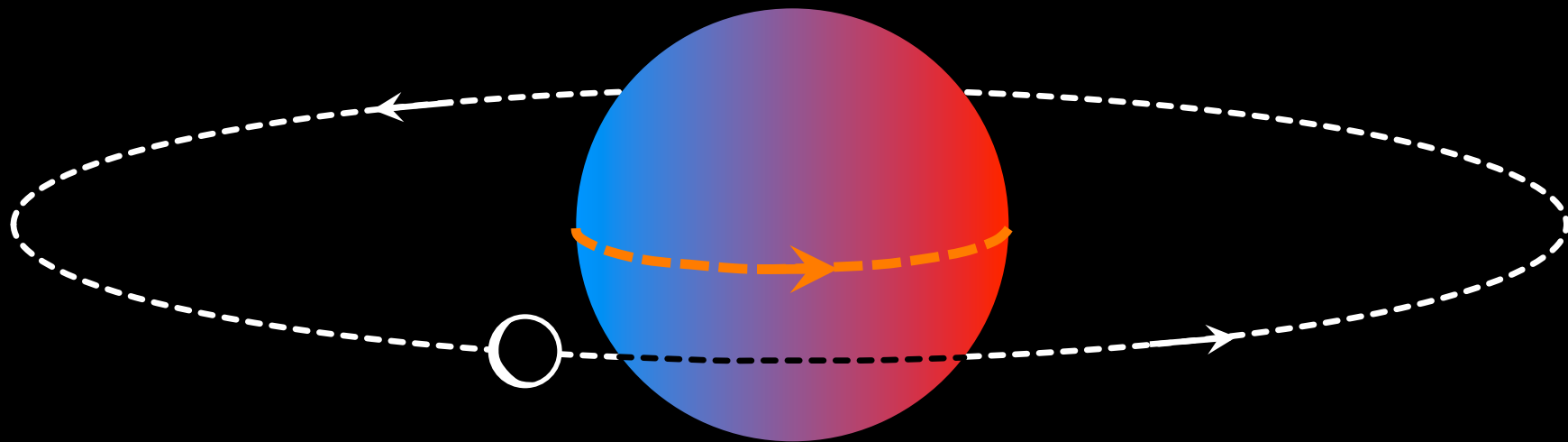

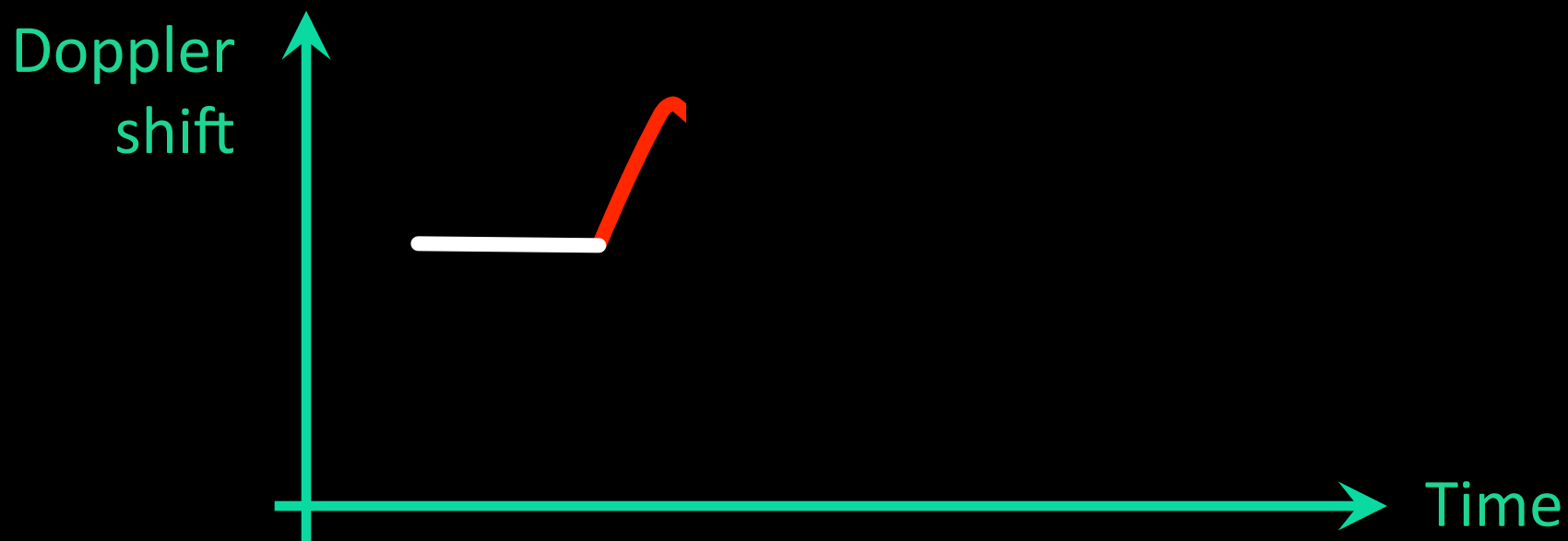
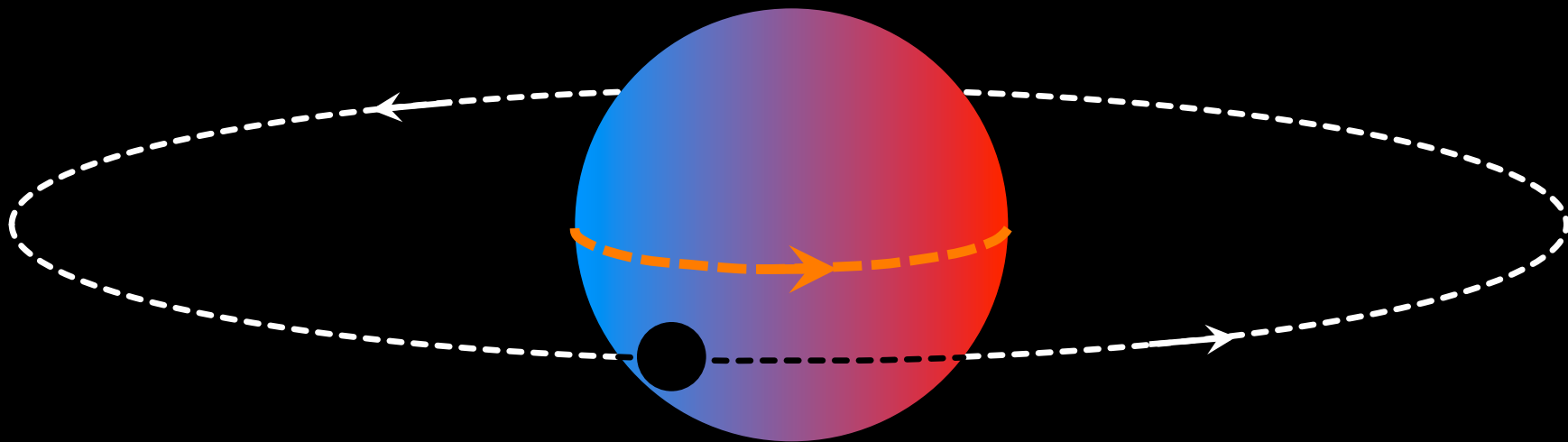

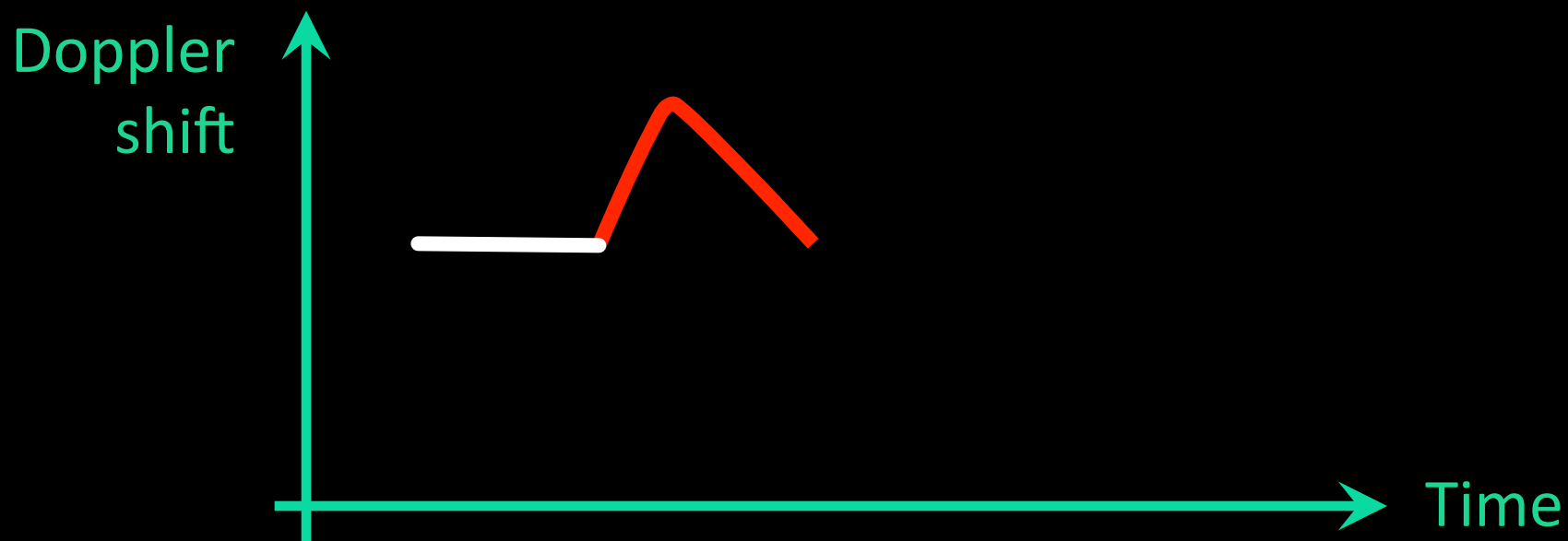
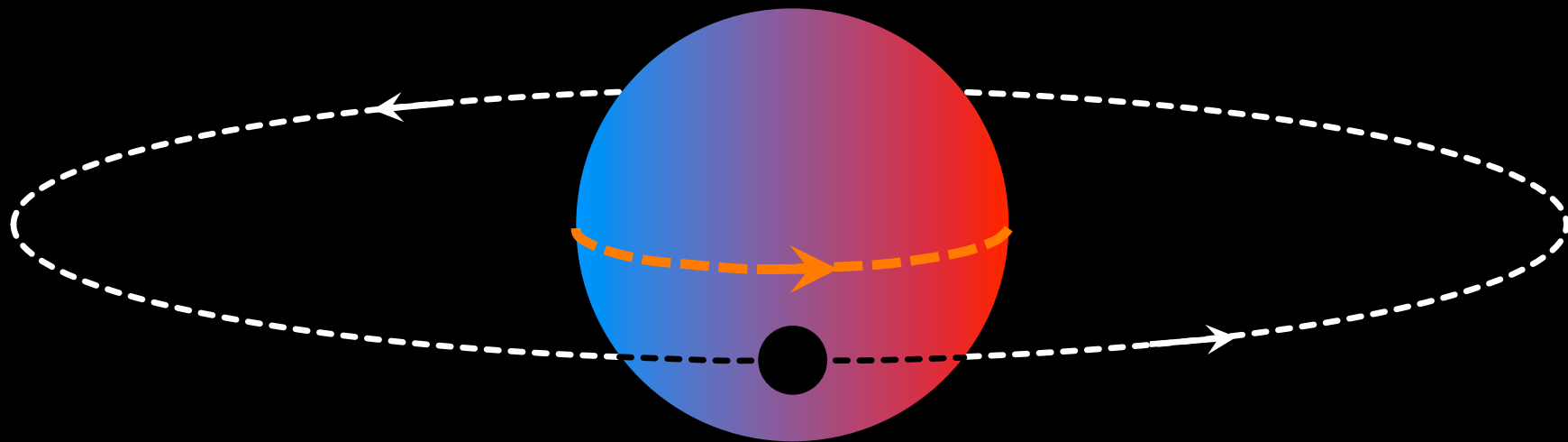

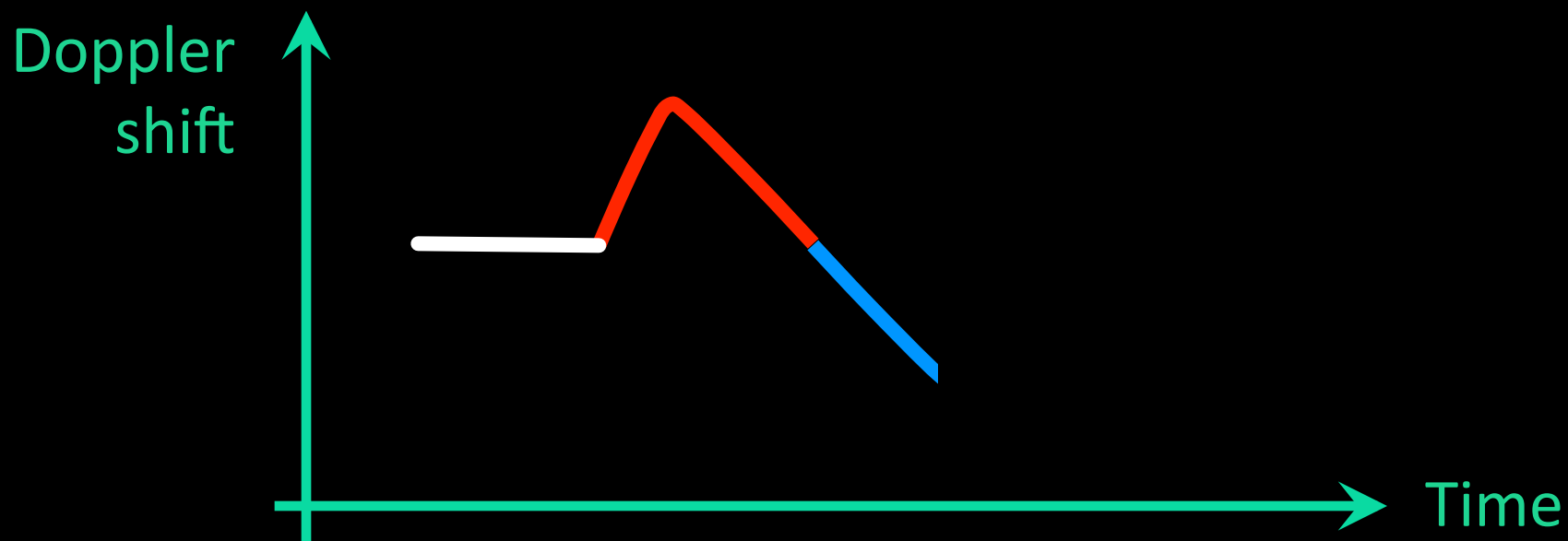
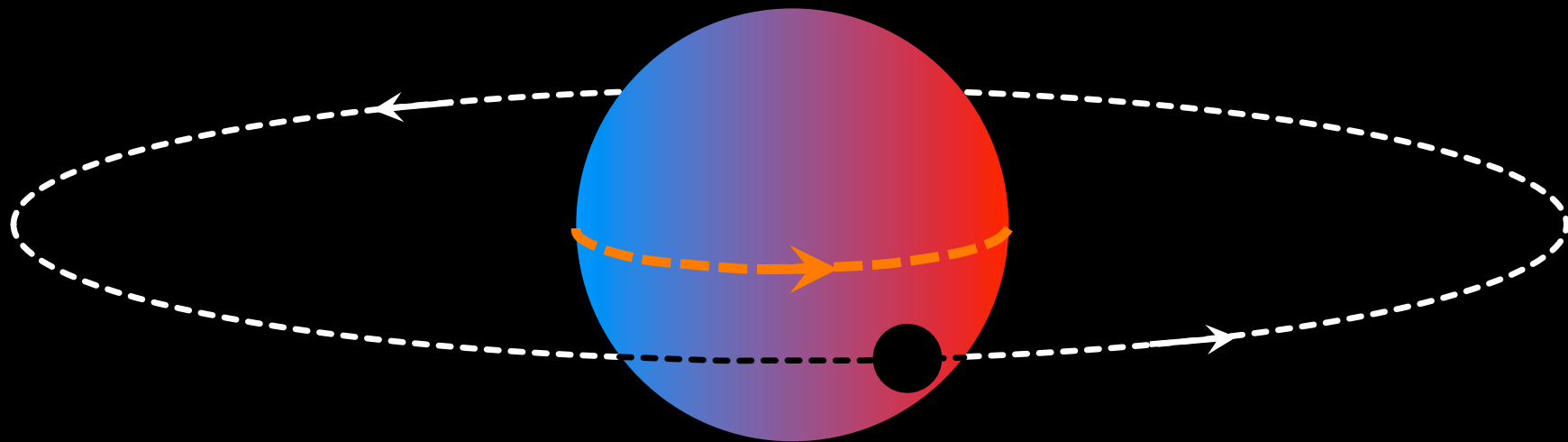

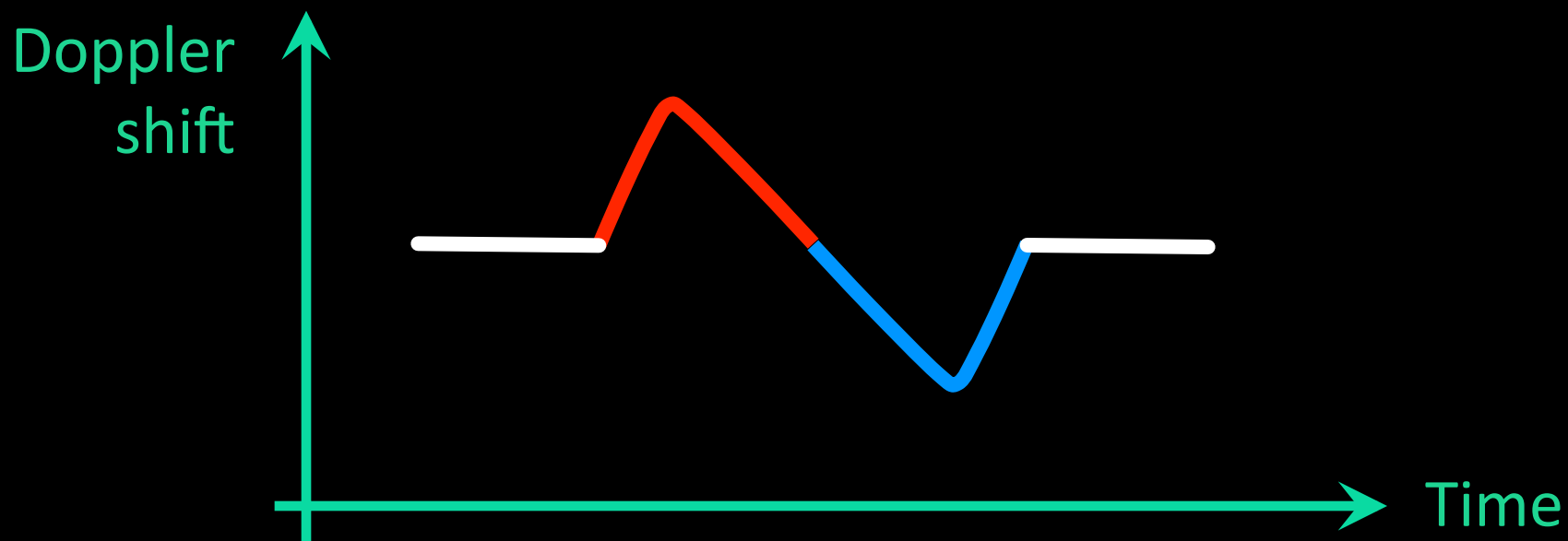
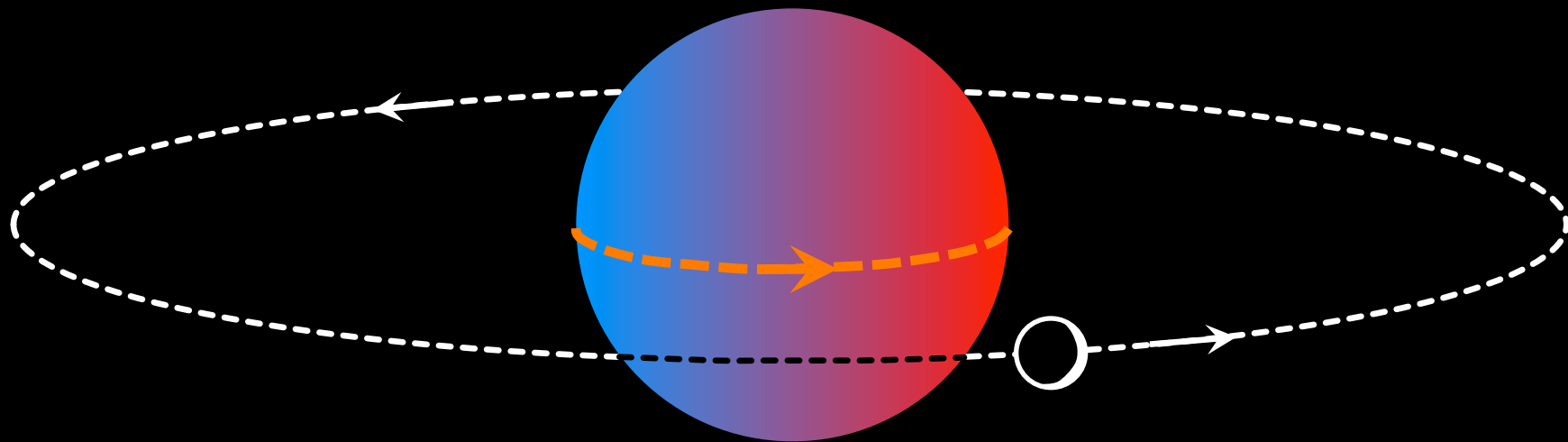

$$\Delta RV \approx 0.7 \sqrt{1 - b^2} \left(\frac{R_p}{R_\star} \right)^2 v_{\text{rot}} \sin I_{\text{rot}}$$

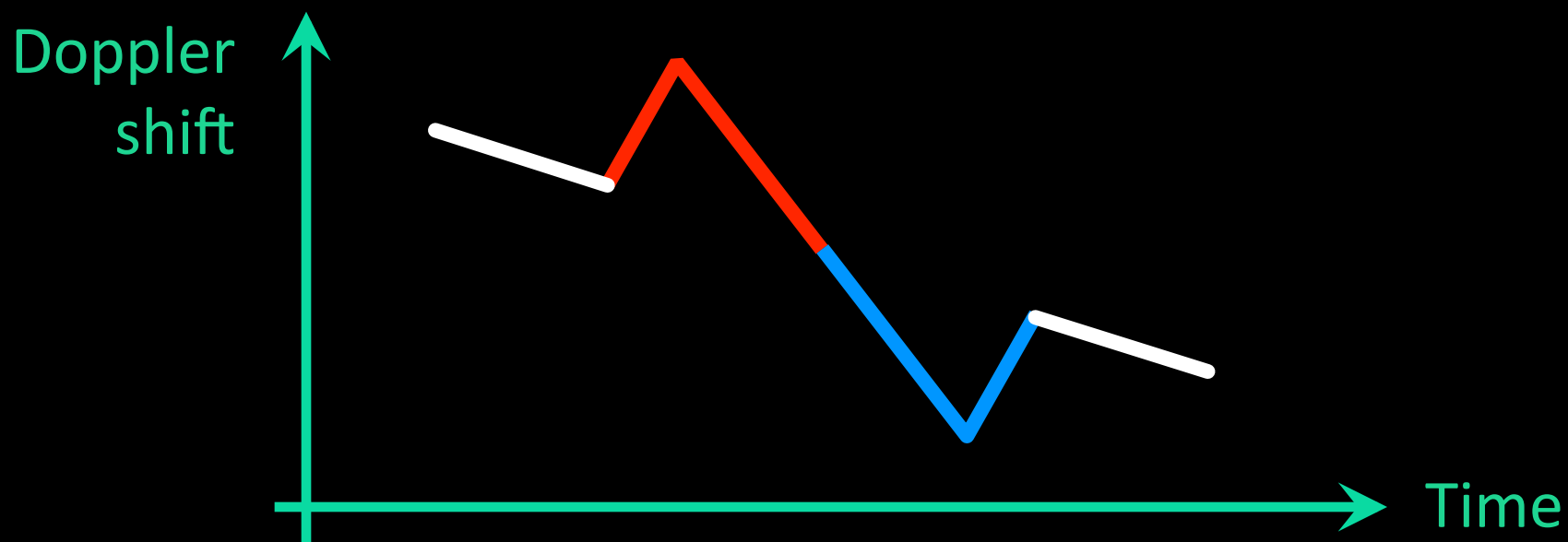
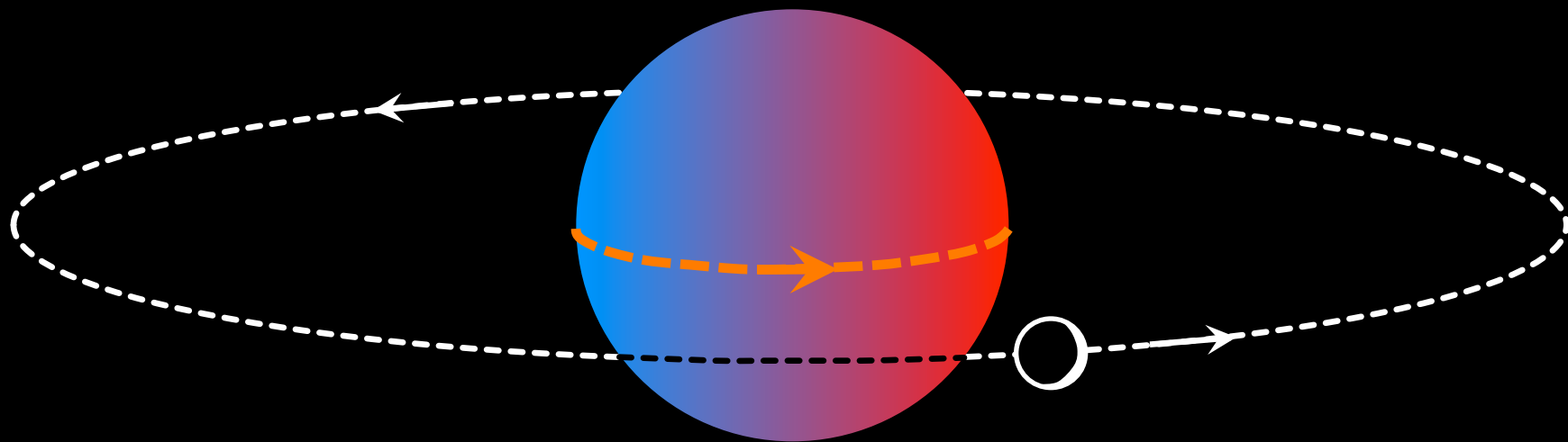

$$\Delta RV \approx 0.7 \sqrt{1 - b^2} \left(\frac{R_p}{R_\star} \right)^2 v_{\text{rot}} \sin I_{\text{rot}}$$

The Rossiter-McLaughlin (RM) effect

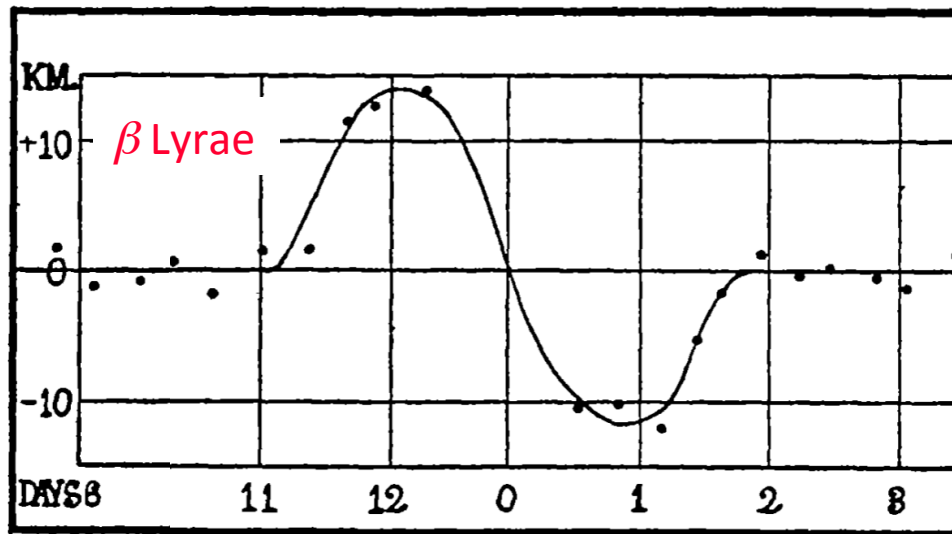

Richard
Rossiter
(1886-1977)

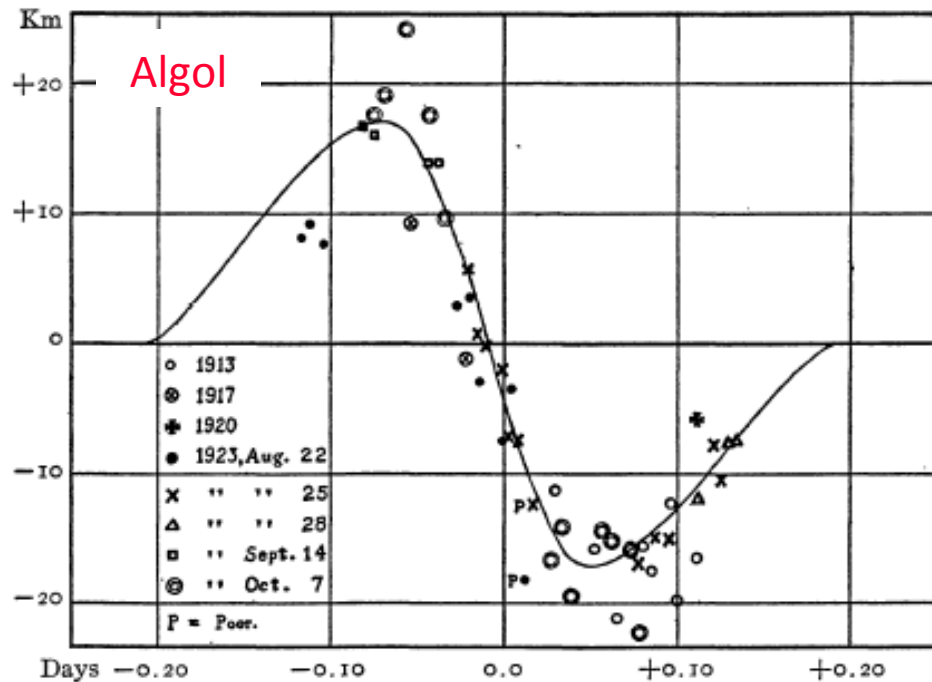

Dean
McLaughlin
(1901-1965)

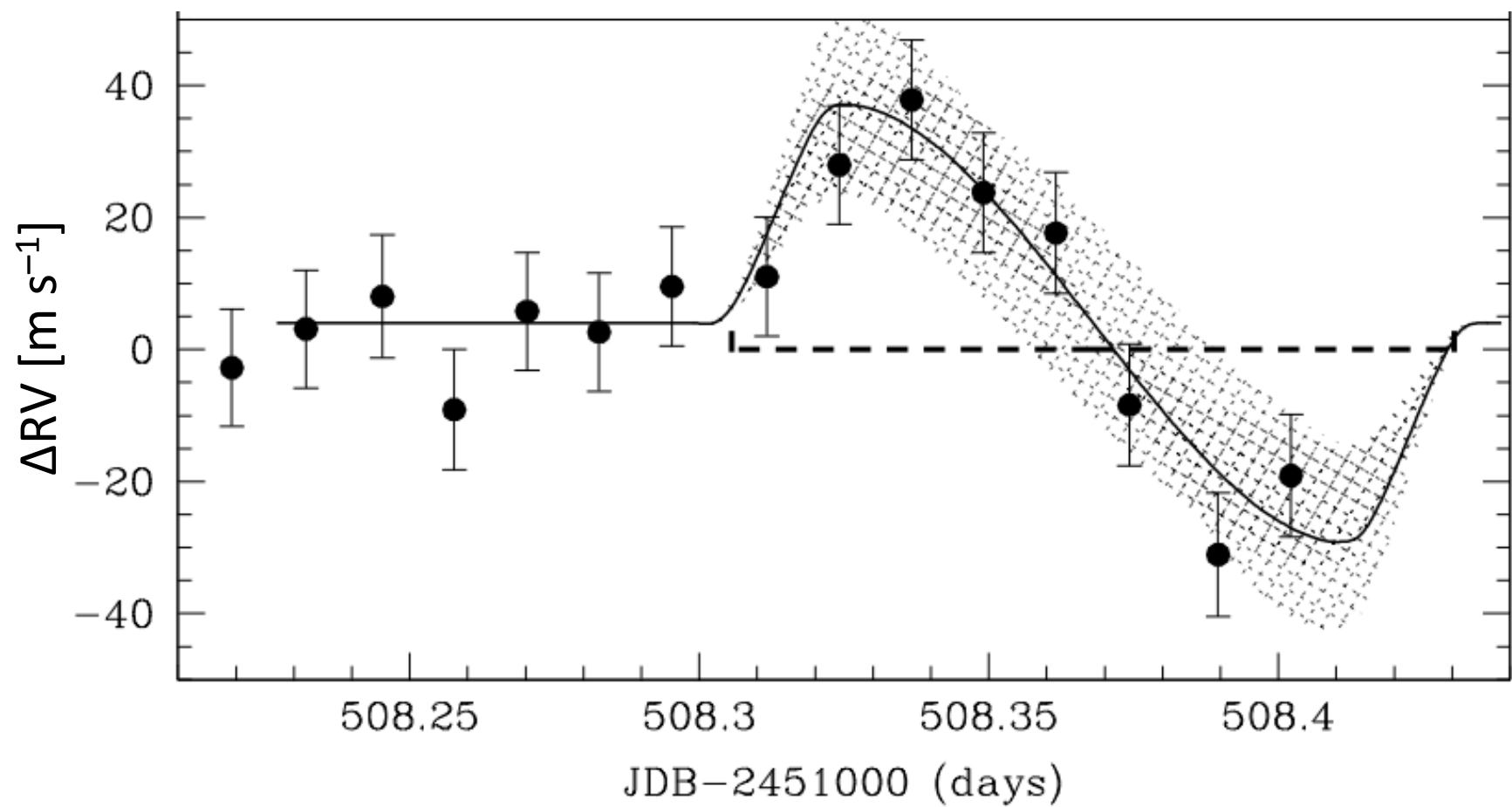

Measuring the stellar obliquity

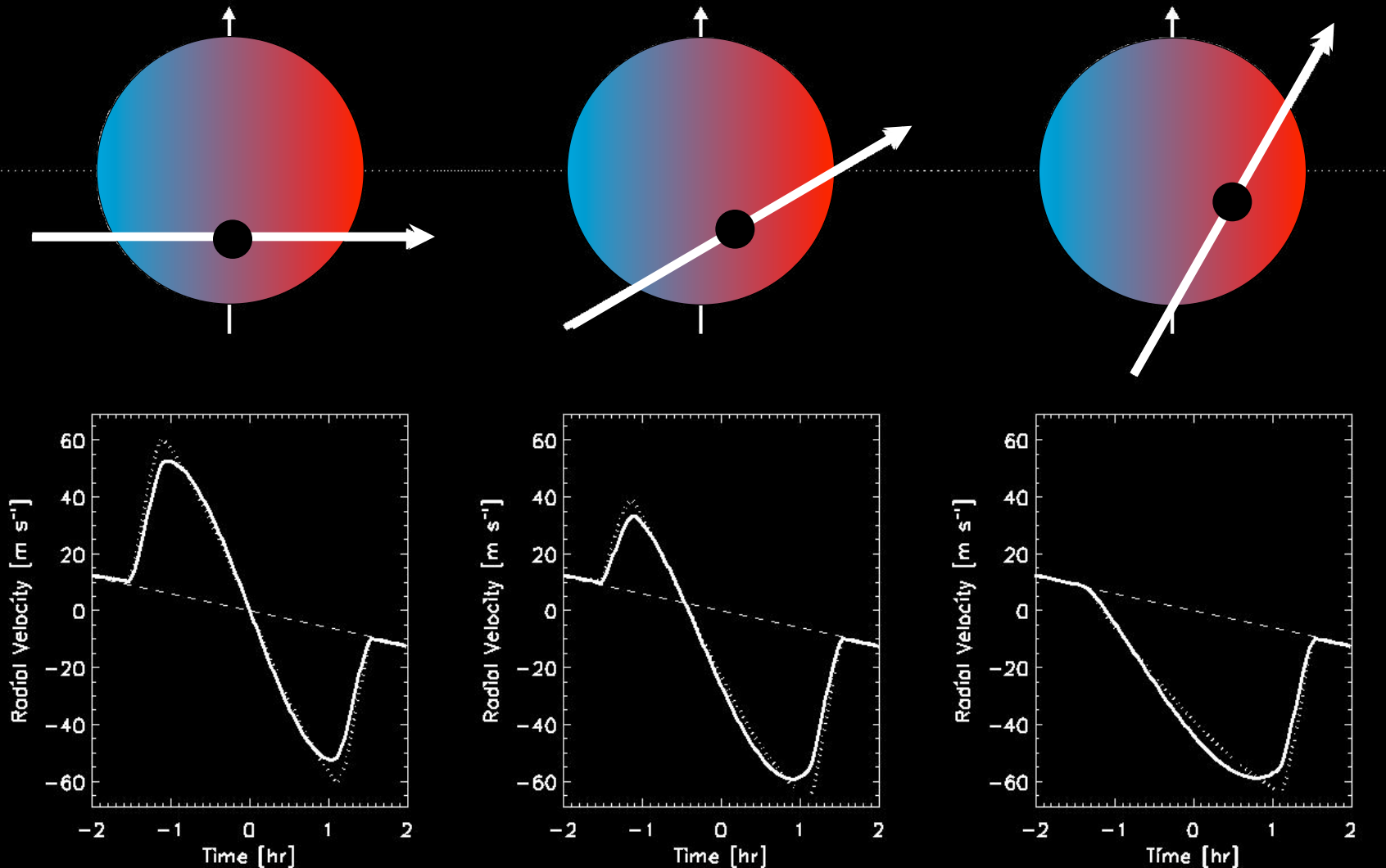

Queloz et al. (2000); Ohta, Taruya, & Suto (2005); Gaudi & Winn (2007)

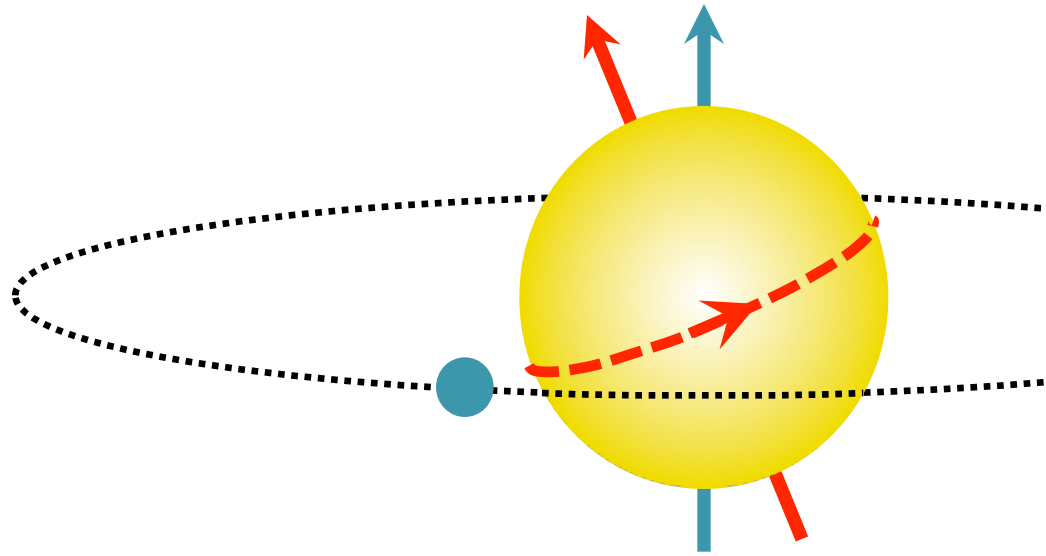

Stellar obliquity

- Sun's obliquity is 7° — how typical is this?
- Whatever produces *hot Jupiters* may also perturb inclinations

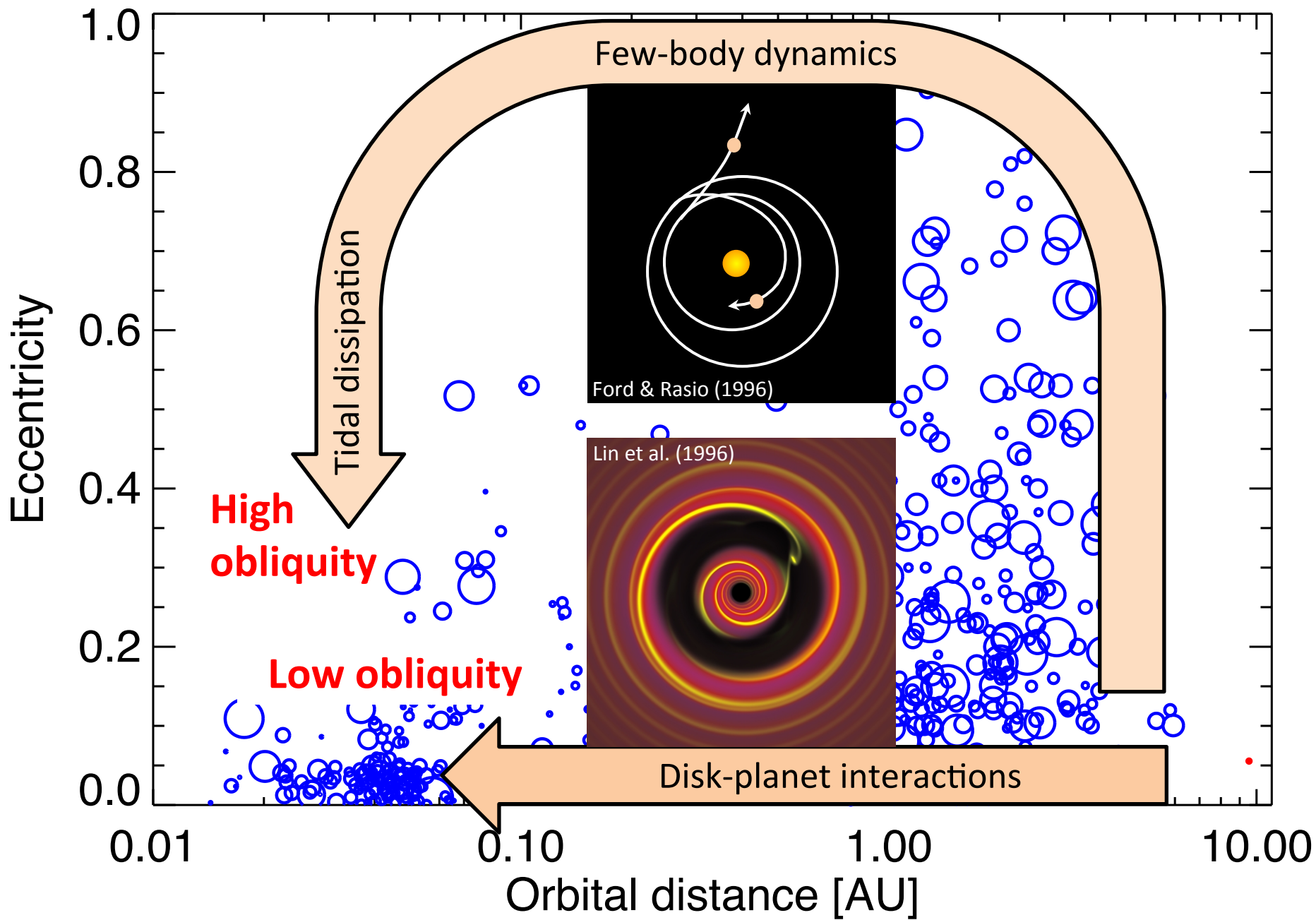

Low obliquity

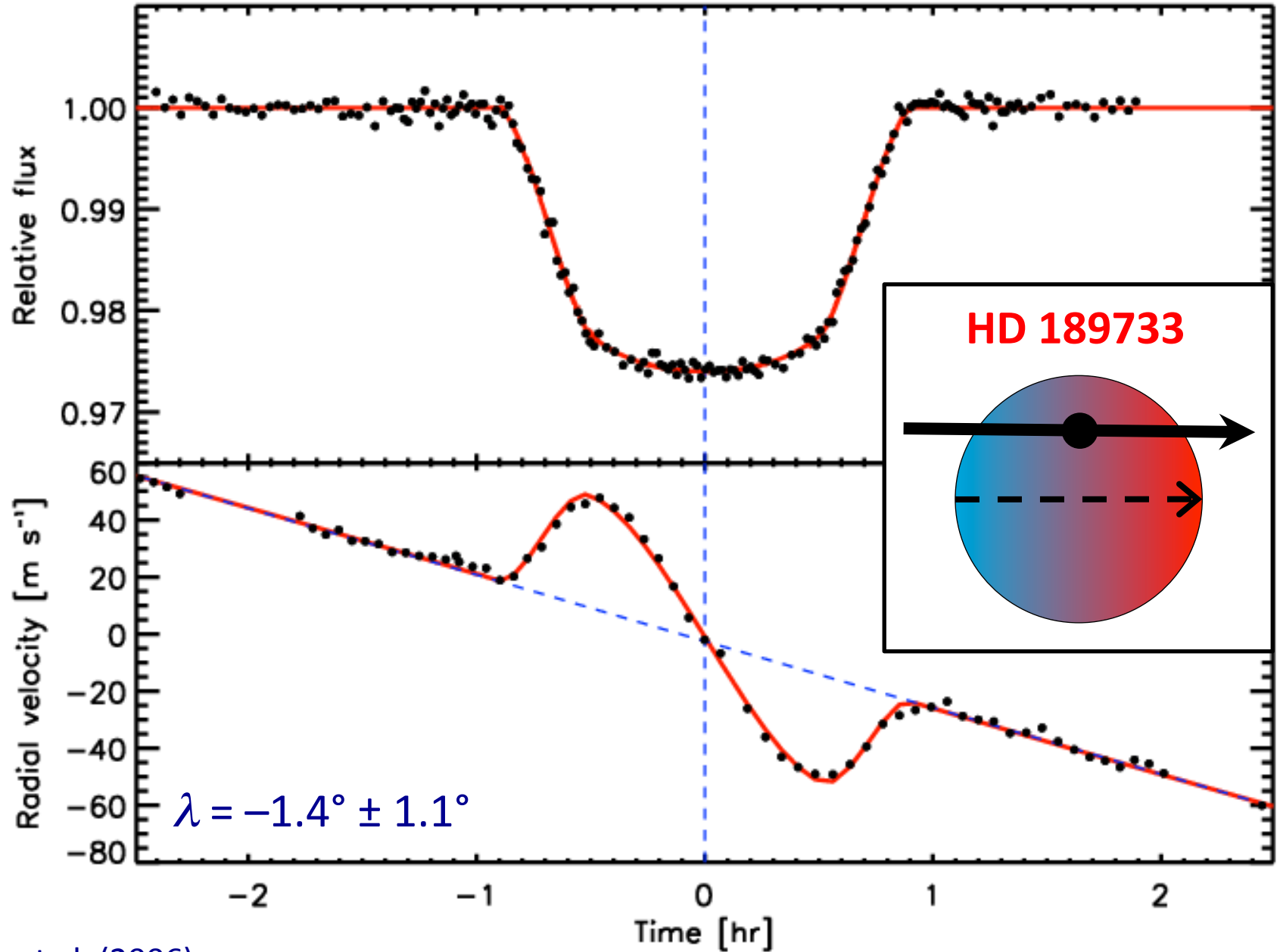

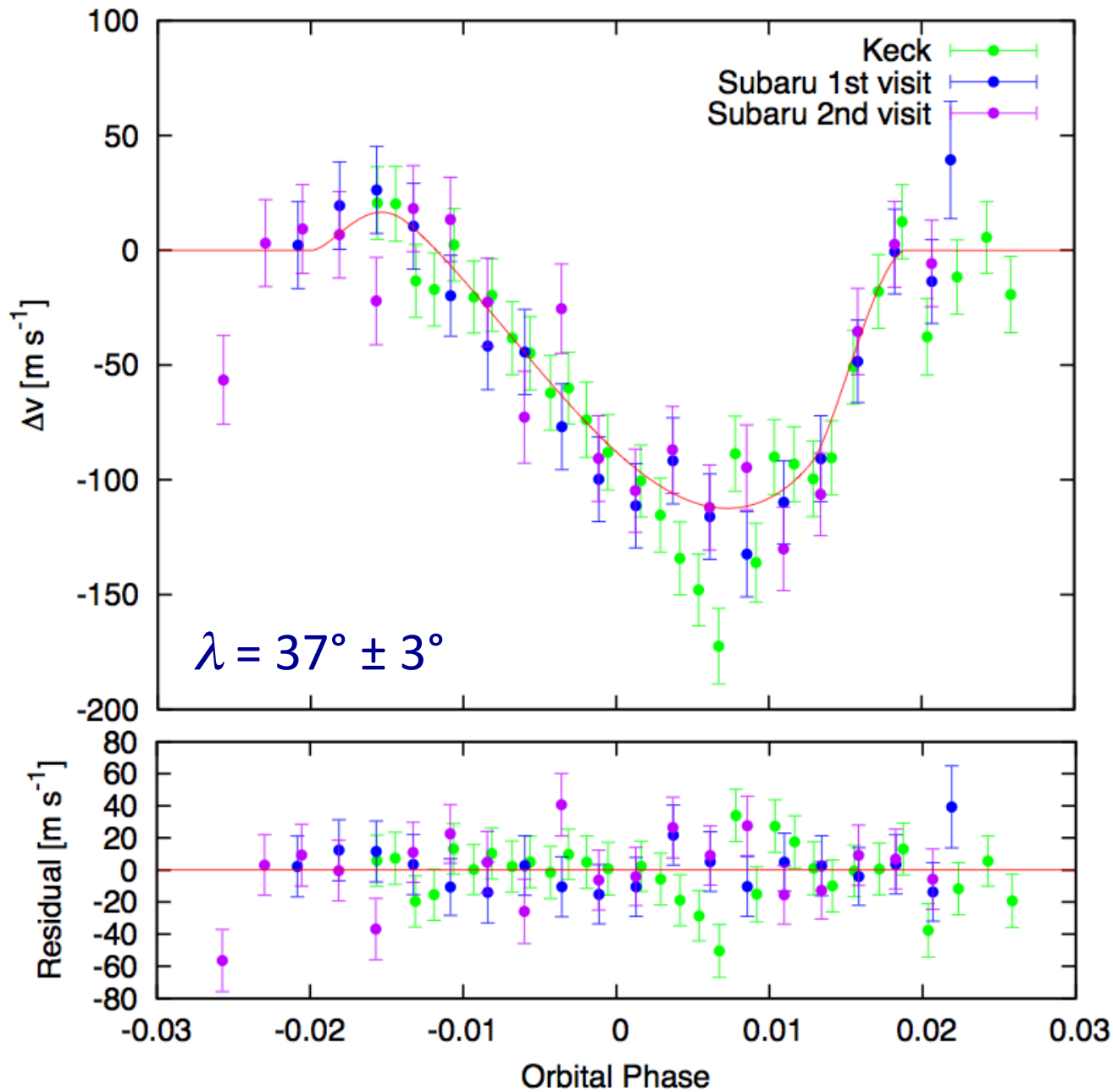

Moderate
obliquity

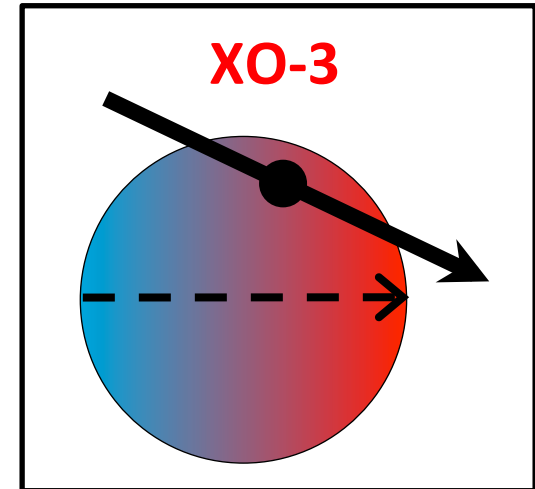

High obliquity

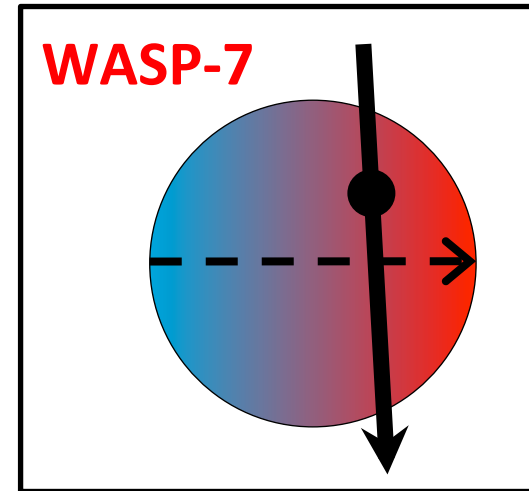
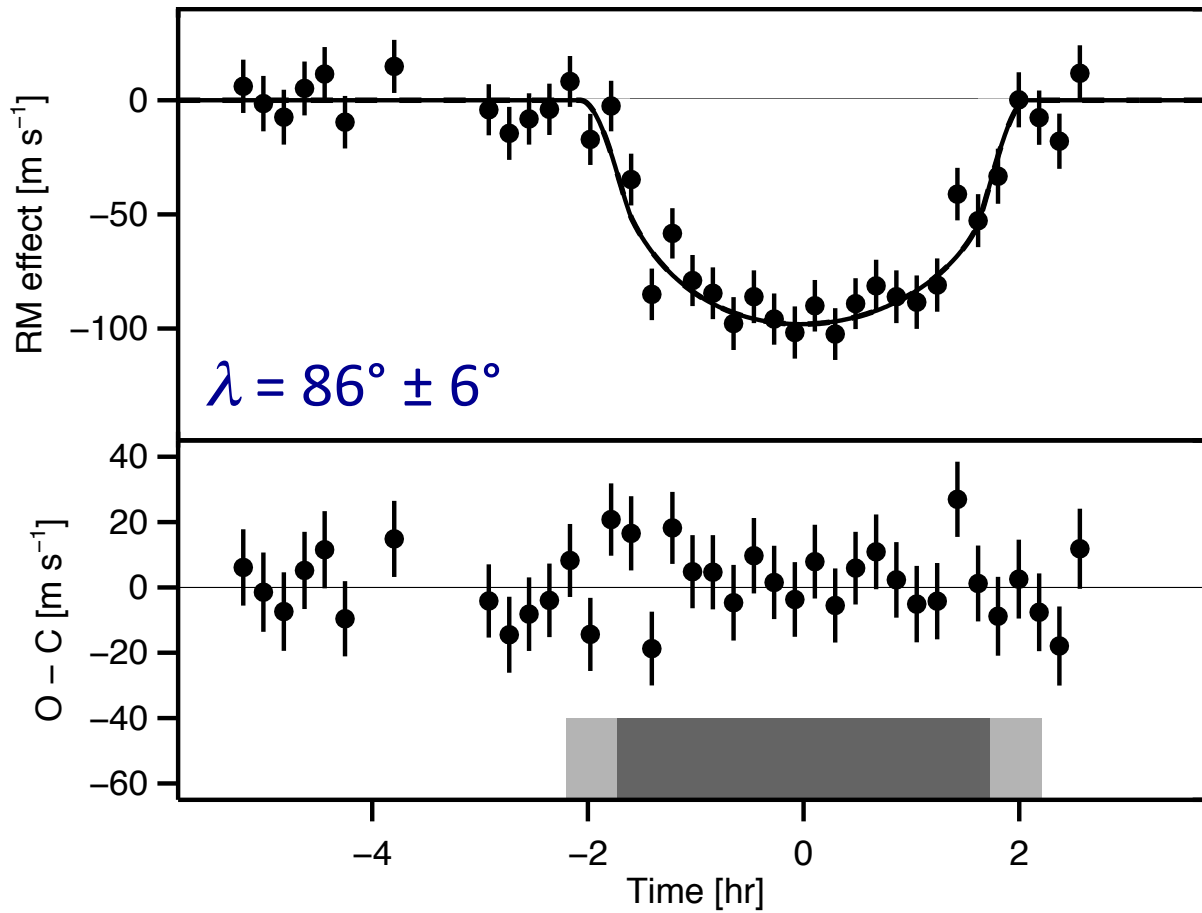

Retrograde

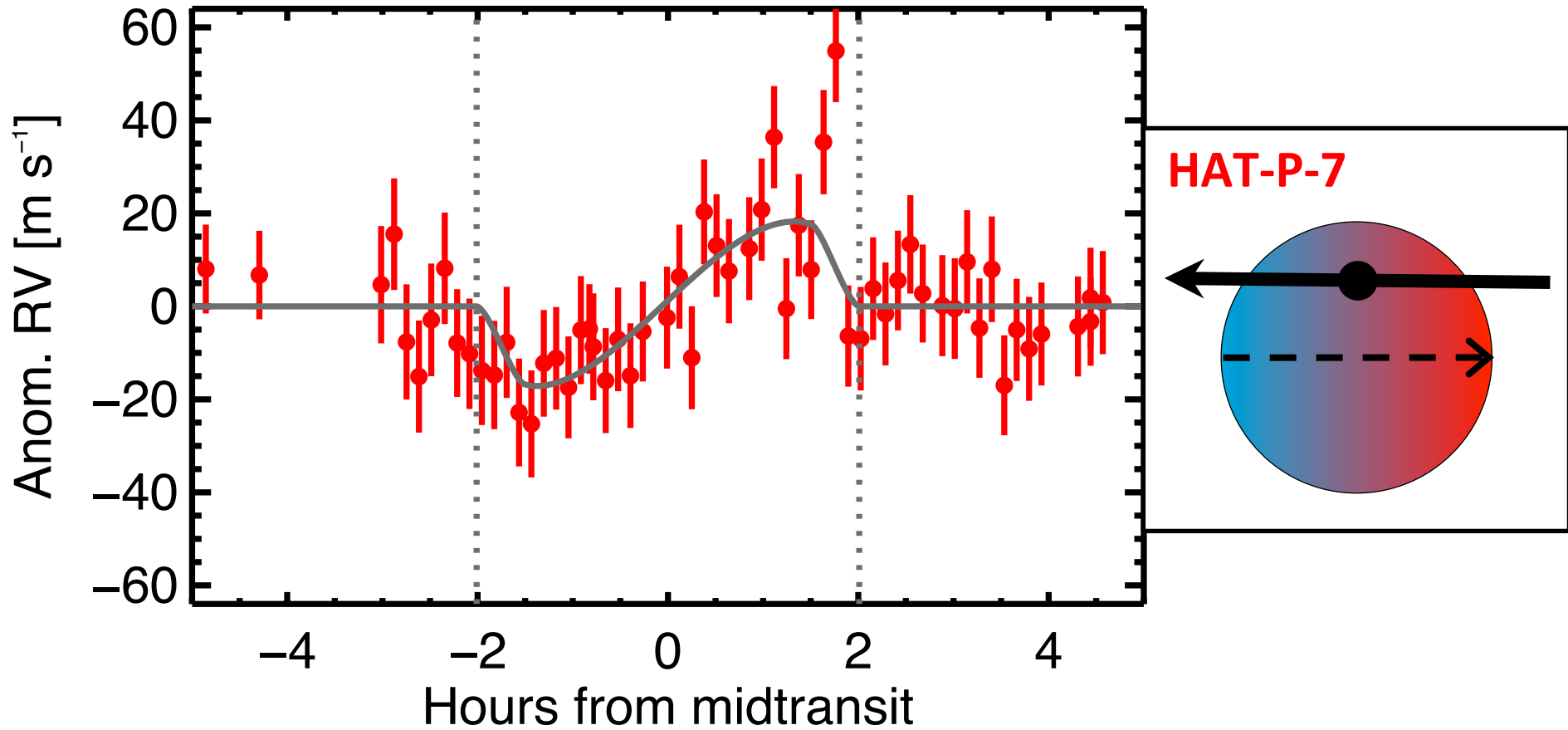

Three phases of a transit

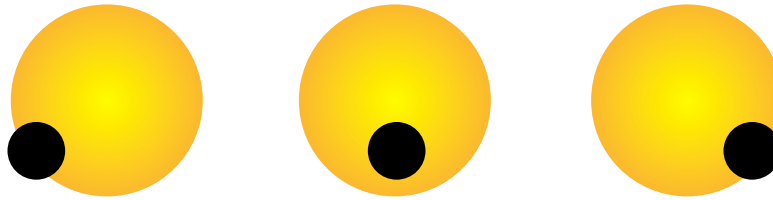

Spin and orbit aligned

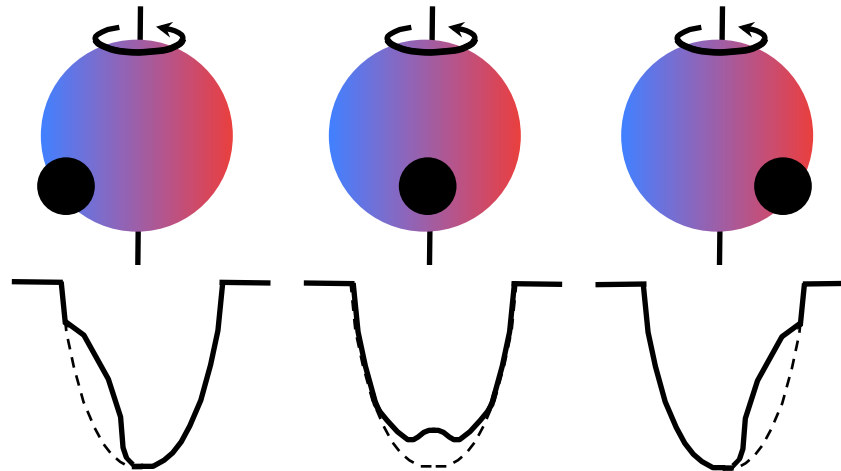

Spin and orbit misaligned by 60°

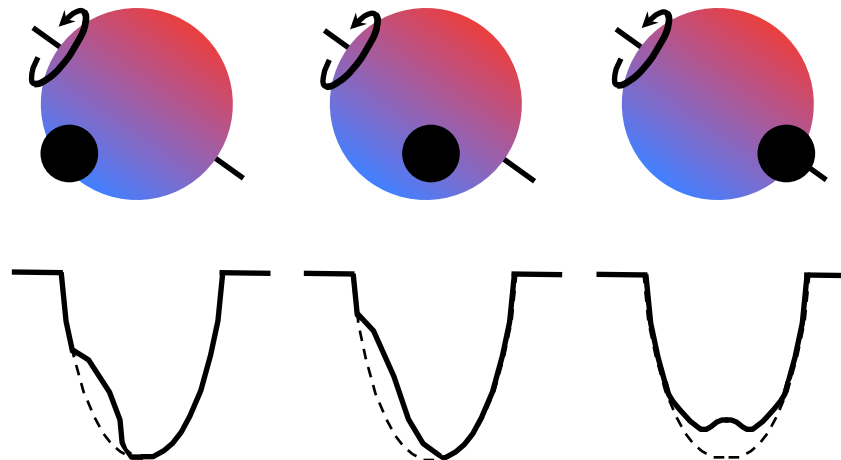

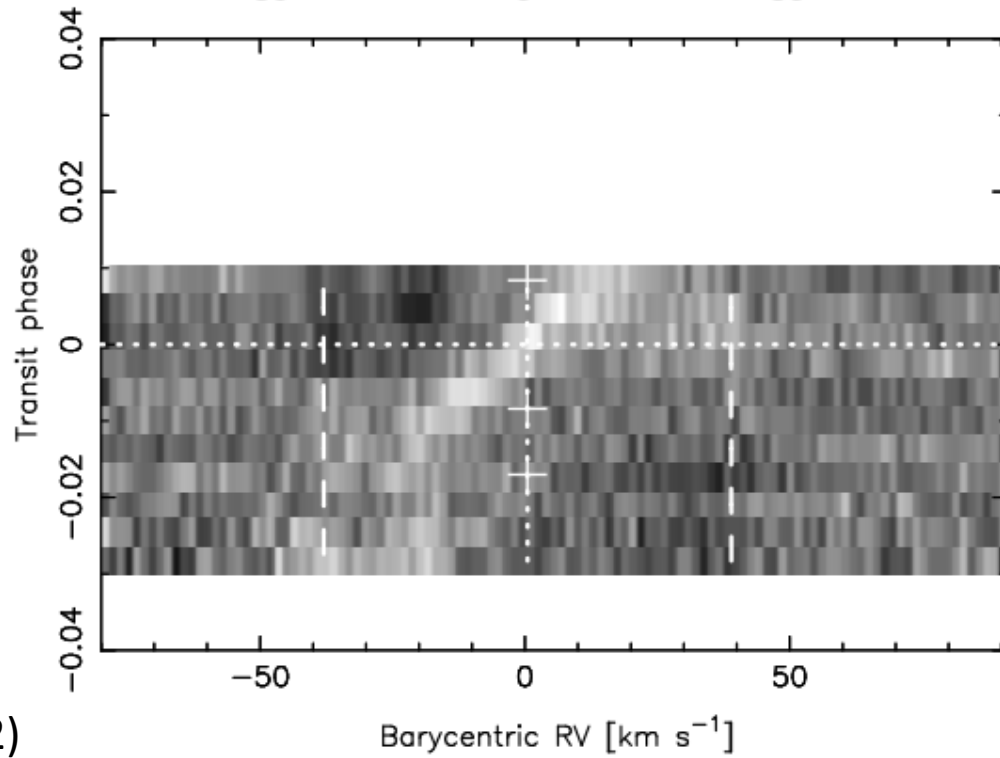
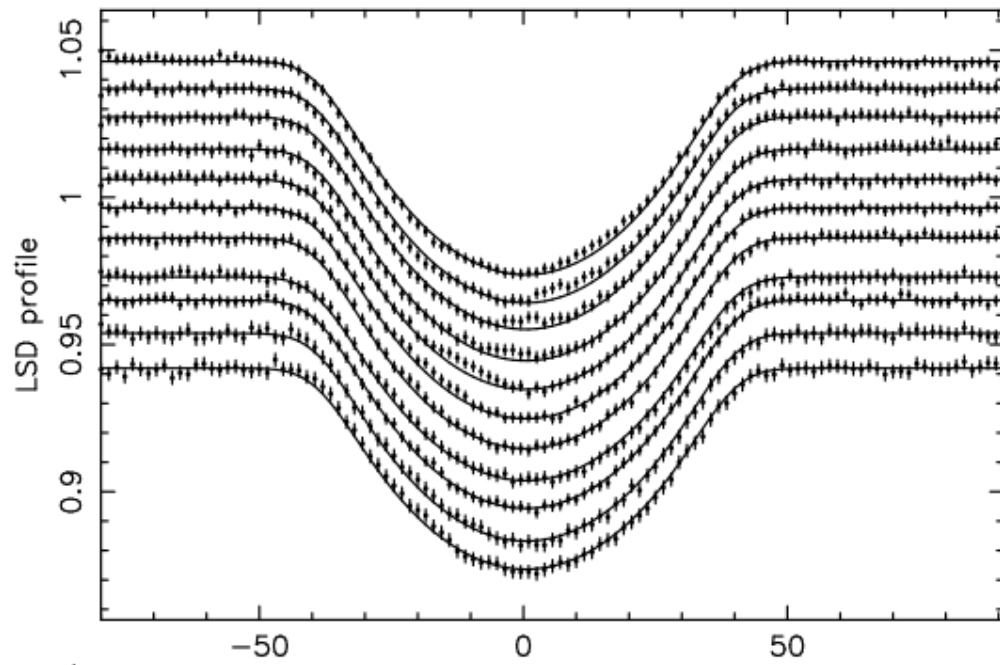

Oblivities of hot-Jupiter hosts

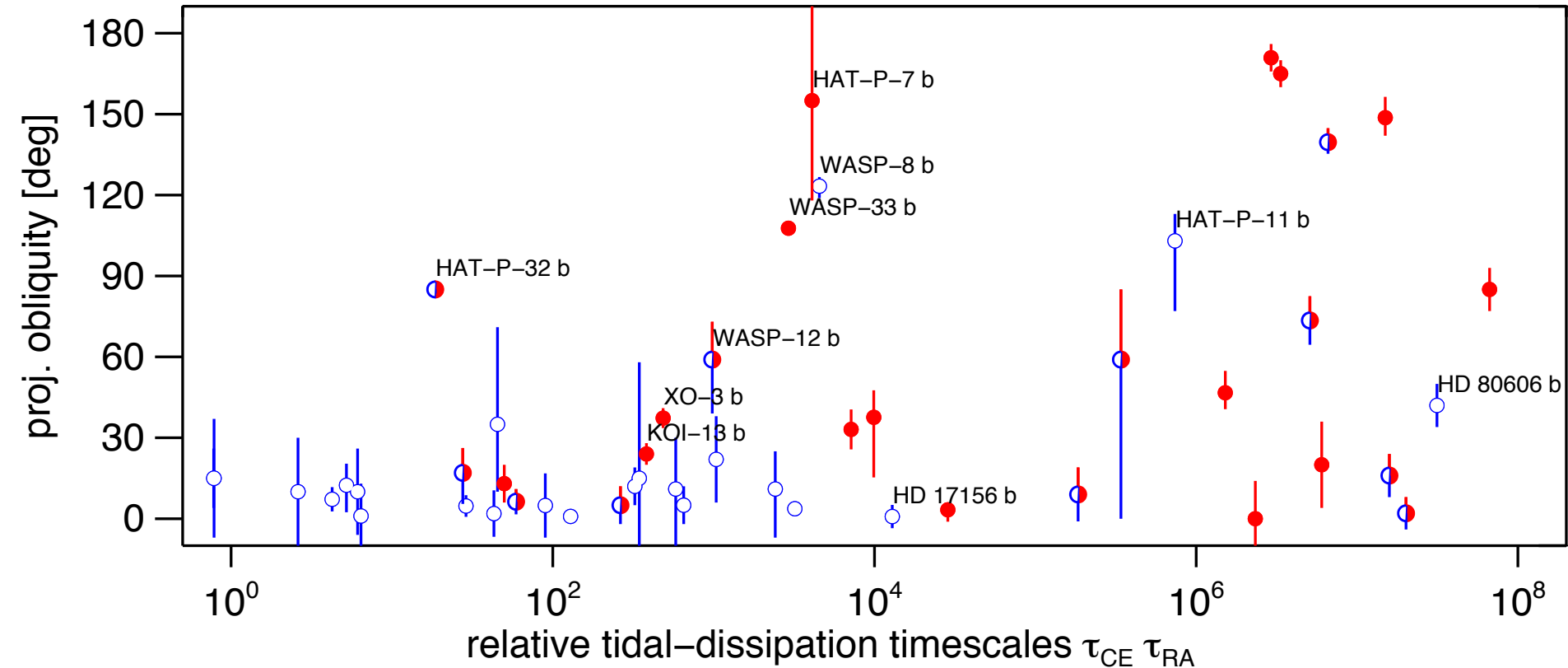

$$\frac{1}{\tau_{\text{CE}}} = \frac{1}{10 \cdot 10^9 \text{yr}} q^2 \left(\frac{a/R_\star}{40} \right)^{-6}$$

$$\frac{1}{\tau_{\text{RA}}} = \frac{1}{0.25 \cdot 5 \cdot 10^9 \text{yr}} q^2 (1+q)^{5/6} \left(\frac{a/R_\star}{6} \right)^{-17/2}$$

